

# XStream-PKG-R™ RS-232/485 RF Modem

---

XStream-PKG-R RS-232/485 RF Modem  
Interfacing Protocols  
RF Operation  
Advanced Programming  
Appendices



## Product Manual v4.2A

For XStream RF Modem Part Numbers:

X09-001PK...-R...  
X09-009PK...-R...  
X09-019PK...-R...

X24-009PK...-R...  
X24-019PK...-R...

XH9-001PK...-R...  
XH9-009PK...-R...  
XH9-019PK...-R...



**MaxStream™**

355 South 520 West, Suite 180  
Lindon, UT 84042  
Phone: (801) 765-9885  
Fax: (801) 765-9895

rf-xperts@maxstream.net  
www.maxstream.net

M100019  
11.15.2004

**© 2004 MaxStream, Inc. All rights reserved**

No part of the contents of this manual may be transmitted or reproduced in any form or by any means without the written permission of MaxStream, Inc.

XStream™ is a trademark of MaxStream, Inc.

Phone: (801) 765-9885

Live Chat: [www.maxstream.net](http://www.maxstream.net)

E-Mail: [rf-xperts@maxstream.net](mailto:rf-xperts@maxstream.net)

# Contents

---

<b>1. XStream™ RS-232/485 RF Modem</b>	<b>4</b>	<b>Appendix A: Agency Certifications</b>	<b>36</b>
<b>Features</b>	<b>4</b>	<b>FCC Certification</b>	<b>36</b>
Worldwide Acceptance	4	OEM Labeling Requirements	37
<b>Specifications</b>	<b>5</b>	Antenna Usage	37
<b>XStream-PKG-R RF Modem Interface</b>	<b>6</b>	FCC-Approved Antennas	38
<b>2. Interfacing Protocols</b>	<b>7</b>	<b>European Compliance (2.4 GHz only)</b>	<b>39</b>
<b>RS-232 Operation</b>	<b>7</b>	Restrictions	39
DIP Switch Settings and Pin Signals	7	Europe (2.4 GHz) Approved Antenna List	40
<b>RS-485 (2-wire) Operation</b>	<b>9</b>	<b>IC (Industry Canada) Certification</b>	<b>40</b>
DIP Switch Settings and Pin Signals	9	<b>Appendix B: Development Guide</b>	<b>41</b>
<b>RS-485 (4-wire) &amp; RS-422 Operation</b>	<b>10</b>	<b>RS-232 Accessories Kit Contents</b>	<b>41</b>
DIP Switch Settings and Pin Signals	10	Adapters	42
<b>3. RF Operation</b>	<b>12</b>	Antennas	43
<b>Serial Communications</b>	<b>12</b>	<b>Appendix C: Additional Information</b>	<b>44</b>
RS-232 and RS-485/422 Data Flow	12	<b>1-Year Warranty</b>	<b>44</b>
Host and RF Modem I/O Settings	12	<b>Ordering Information</b>	<b>44</b>
Flow Control	13	<b>Contact MaxStream</b>	<b>45</b>
<b>Modes of Operation</b>	<b>14</b>		
Idle Mode	14		
Transmit Mode	14		
Receive Mode	16		
Sleep Mode	16		
Command Mode	17		
<b>4. Advanced Programming</b>	<b>19</b>		
<b>Automatic DIP Switch Configurations</b>	<b>19</b>		
<b>Programming the Modem</b>	<b>20</b>		
AT Command Examples	20		
Binary Command Example	21		
<b>Command Descriptions (short)</b>	<b>22</b>		
<b>Command Descriptions (long)</b>	<b>23</b>		

# 1. XStream™ RS-232/485 RF Modem

The XStream-PKG-R RF Modem provides long range data communications and advanced networking for the expanding RFd2d (Radio Frequency Device-to-Device) segment of the wireless market. Simply feed data into one RF modem; then at the speed-of-light, the data is sent out the receiving end of the long range wireless link.



The RF modem is easy-to-use and requires no configuration for out-of-box RF operations. The modem transfers a standard asynchronous serial data stream between two or more modems.

## Features

### Long Range

9XStream-PKG-R (900 MHz) Range:

- Indoor/Urban: **up to 1500'** (450 m)
- Outdoor line-of-sight: **up to 7 miles** (11 km) w/ 2.1 dBm dipole antenna
- Outdoor line-of-sight: **up to 20 miles** (32 km) w/ high gain antenna

24XStream-PKG-R (2.4 GHz) Range:

- Indoor/Urban: **up to 600'** (180 m)
- Outdoor line-of-sight: **up to 3 miles** (5 km) w/ 2.1 dBm dipole antenna
- Outdoor line-of-sight: **up to 10 miles** (16 km) w/ high gain antenna

Receiver Sensitivity: **-110 dBm** (900 MHz), **-105 dBm** (2.4 GHz)

### Advanced Networking & Security

True peer-to-peer (no "master" required), point-to-point, point-to-multipoint, multidrop  
Retries and Acknowledgements  
7 hopping channels, each with over 65,000 available network addresses  
FHSS (Frequency Hopping Spread Spectrum)

### Easy-to-Use

Out-of-Box RF Experience, no configuration required

External DIP Switch for configuring:

- RS-232/485/422 support (multidrop included)
- 2-wire (half-duplex) or 4-wire RS-485/422 operation
- Multiple data formats (7/8/9 Bits, Even/Odd/Mark/Space Parity)

7-18 VDC power supply

Simple AT and Binary commands for advanced programming

Software-selectable serial interfacing rates

MODBUS, CTS, RTS, DTR, DCD (& more) I/O Support

XII™ Interference Blocking

Power-saving Sleep Modes (as low as 1 mA)

**Free & Unlimited World-Class Technical Support**

### Worldwide Acceptance

**FCC Certified** (USA) - Refer to Appendix A for FCC Requirements.

Systems that contain XStream RF Modems inherit MaxStream's FCC Certification.

**ISM** (Industrial, Scientific & Medical) frequency band

Manufactured under **ISO 9001:2000 registered standards**

9XStream (900 MHz) RF Modems are approved for use in **US, Canada, Australia, Israel** (and more). 24XStream (2.4 GHz) Modems add **Europe** (EU) and other approvals.



## Specifications

Table 1.1. XStream-PKG-R RS-232/485 RF Modem Specifications

Specification	9XStream-PKG-R (900 MHz)		24XStream-PKG-R (2.4 GHz)	
<b>Performance</b>				
Indoor/Urban Range	Up to 1500' (450 m)		Up to 600' (180 m)	
Outdoor LOS Range	Up to 7 miles (11 km) w/ dipole antenna Up to 20 miles (32 km) w/ high-gain antenna		Up to 3 miles (5 km) w/ dipole antenna Up to 10 miles (16 km) w/ high-gain antenna	
Transmit Power Output	100 mW (20 dBm)	100 mW (20 dBm)	50 mW (17 dBm)	50 mW (17 dBm)
Serial Data Throughput	<b>9600 bps</b>	<b>19.2 kbps</b>	<b>9600 bps</b>	<b>19.2 kbps</b>
RF Baud Rate	10,000 bps	20,000 bps	10,000 bps	20,000 bps
Receiver Sensitivity	-110 dBm	-107 dBm	-105 dBm	-102 dBm
<b>General</b>				
Frequency	902-928 MHz		2.4000-2.4835 GHz	
Spread Spectrum	Frequency Hopping, Wide band FM modulator		Frequency Hopping, Wide band FM modulator	
Network Topology	Peer-to-Peer, Point-to-Multipoint, Point-to-Point, Multidrop		Peer-to-Peer, Point-to-multipoint, Point-to-Point, Multidrop	
Channel Capacity	7 hop sequences share 25 frequencies		7 hop sequences share 25 frequencies	
Serial Data Interface	RS-232/485/422		RS-232/485/422	
I/O Data Rate	Software selectable 1200 - 57600 bps		Software selectable 1200 - 57600 bps	
<b>Power Requirements</b>				
Supply Voltage	7-18 VDC		7-18 VDC	
Transmit Current	200 mA		200 mA	
Receive Current	70 mA		70 mA	
Power Down Current	< 1 mA		< 1 mA	
<b>Physical Properties</b>				
Enclosure	7.1 oz. (200 g), Extruded aluminum, black anodized		7.1 oz. (200 g), Extruded aluminum, black anodized	
Enclosure Size	2.75" x 5.50" x 1.124" (7.90 cm x 13.90 cm x 3.80 cm)		2.75" x 5.50" x 1.124" (7.90 cm x 13.90 cm x 3.80 cm)	
Operating Temperature	0 to 70° C (commercial), -40 to 85° C (industrial)		0 to 70° C (commercial), -40 to 85° C (industrial)	
<b>Antenna</b>				
Type	½ wave dipole whip, 6.75" (17.1 cm), 2.1 dBi Gain		½ wave dipole whip, 5.25" (13.3 cm), 2.1 dBi Gain	
Connector	Reverse-polarity SMA		Reverse-polarity SMA	
Impedance	50 ohms unbalanced		50 ohms unbalanced	
<b>Certifications</b> (Refer to <a href="http://www.maxstream.net">www.maxstream.net</a> for additional certifications)				
FCC Part 15.247	OUR9XSTREAM		OUR24XSTREAM	
Industry Canada (IC)	4214A-9XSTREAM		4214A 12008	
Europe	N/A		ETSI, CE	



# XStream-PKG-R RF Modem Interface

Figure 1.1. Front View

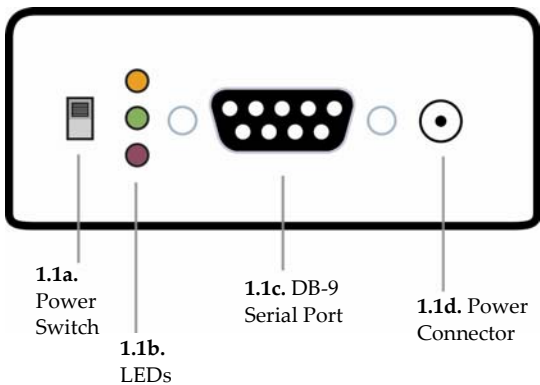

## 1.1a. Power Switch

Move the Power Switch to the on (up) position to power the Interface Board. DIP Switch [1.2a] settings are only read during a power-up sequence.

## 1.1b. LEDs

The LED indicators visualize diagnostic status information. The modem's status is represented as follows:

**Yellow** (top LED) = Serial Data Out (to host)

**Green** (middle) = Serial Data In (from host)

**Red** (bottom) = Power/TX Indicator (Red light is on when powered, off briefly during RF transmission)



## 1.1c. Serial Port (DB-9 Connector)

Standard female DB-9 (RS-232) DCE connector – This connector can be also used for RS-485 and RS-422 connections.

## 1.1d. Power Connector

7-18 VDC Power Connector (Center positive, 5.5/2.1mm) – Power can also be supplied through Pin 9 of the DB-9 Serial Port.

Figure 1.2. Back View

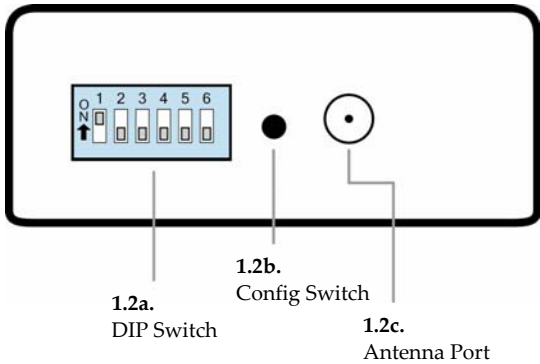

## 1.2a. DIP Switch

The DIP Switch automatically configures the XStream RF Modem to operate in different modes. Each time the modem is powered-on, intelligence inside the XIB-R interface board (inside the modem) programs the modem according to the positions of the DIP Switch. [See figure below for DIP Switch settings]

**NOTE:** In cases where AT Commands should not be sent each time the RF Modem is powered-on, the processor must be disabled by populating J7 on the interface board inside the modem [see p19].

## 1.2b. Config (Configuration) Switch

The Configuration Switch provides an alternate way to enter "AT Command Mode". To enter "AT Command Mode" at the RF modem's default baud rate, hold the Configuration Switch down while powering on the modem using the Power Switch [1.1a].

## 1.2c. Antenna Port

Port is a 50Ω RF signal connector for connecting to an external antenna. The connector type is RPSMA (Reverse Polarity SMA) female.

The connector has threads on the outside of a barrel and a male center conductor.

Figure 1.3. DIP Switch Settings

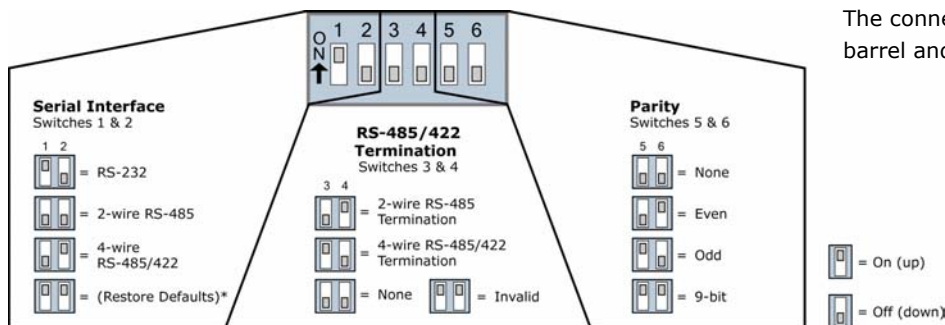

Refer to table in the "Automatic DIP Switch Configurations" section for more information about configurations triggered by the DIP Switch.

# 2. Interfacing Protocols

The XStream-PKG-R RF Modem supports the following interfacing protocols:

- RS-232
- RS-485 (2-wire) Half-Duplex
- RS-485 (4-wire) and RS-422

## RS-232 Operation

### DIP Switch Settings and Pin Signals

Figure 2.1. RS-232 DIP Switch Settings

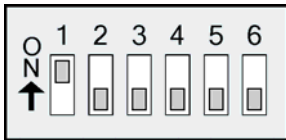

DIP Switch settings are read and applied only while powering-on.

Figure 2.2. Pins used on the female RS-232 (DB-9) Serial Connector

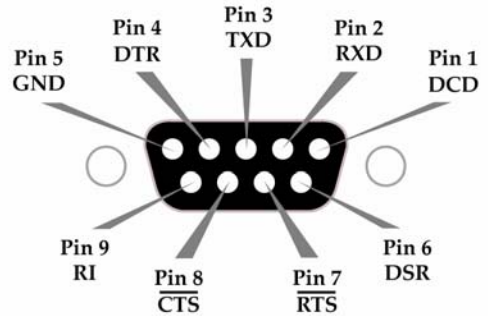

Table 2.1. RS-232 Signals and their implementations on the XStream RF Modem  
(Low-asserted signals are distinguished by horizontal line over pin name.)

DB-9 Pin	RS-232 Name	AT Command Reference*	Description	Implementation
1	DCD	DO3	Data-Carrier-Detect	Connected to DSR (pin6)
2	RXD	DO	Received Data	Serial data exiting the RF Modem (to host)
3	TXD	DI	Transmitted Data	Serial data entering into the RF modem (from host)
4	DTR	DI3	Data-Terminal-Ready	Can enable POWER-DOWN on the RF Modem
5	GND	-	Ground Signal	Ground
6	DSR	DO3	Data-Set-Ready	Connected to DCD (pin1)
7	<u>RTS</u> / CMD	DI2	Request-to-Send	Provides <u>RTS</u> flow control or enables "Command Mode" on the RF Modem
8	<u>CTS</u>	DO2	Clear-to-Send	Provides <u>CTS</u> flow control
9	RI	-	Ring Indicator	Optional power input that is connected internally to the positive lead of the front power connector

\* The AT Command Reference provides as associative tag when using the AT commands to program the RF modem. "DI" stands for Data Input and "DO" for Data Output.

**Wiring Diagram: RS-232 DTE Device to a DCE RF Modem**

Figure 2.3. RS-232 DTE (male connector) device wired to an XStream RF Modem (female connector)

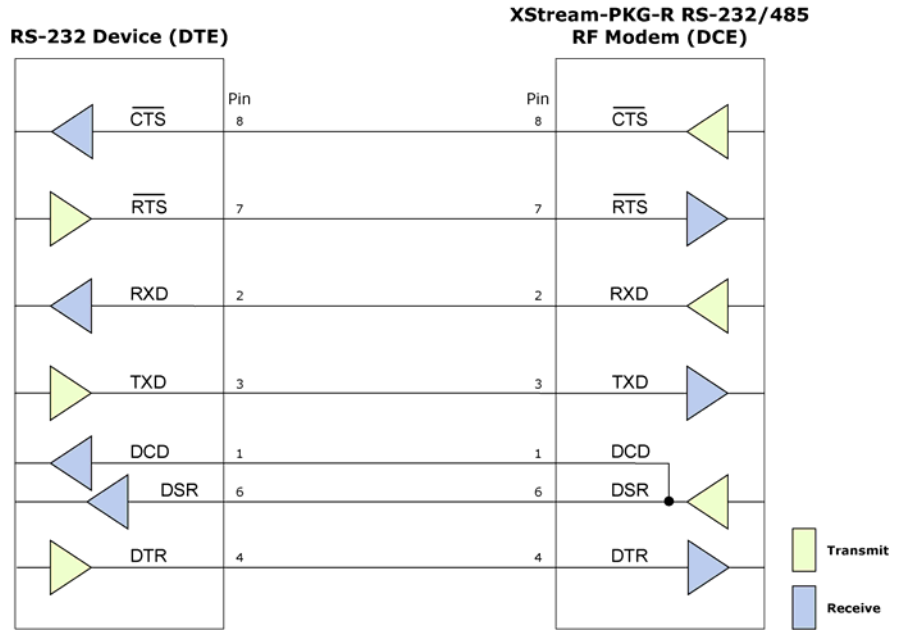

**Wiring Diagram: DCE RF Modem to an RS-232 DCE Device**

Figure 2.4. XStream RF Modem (female connector) wired to an RS-232 DTE (male connector) device

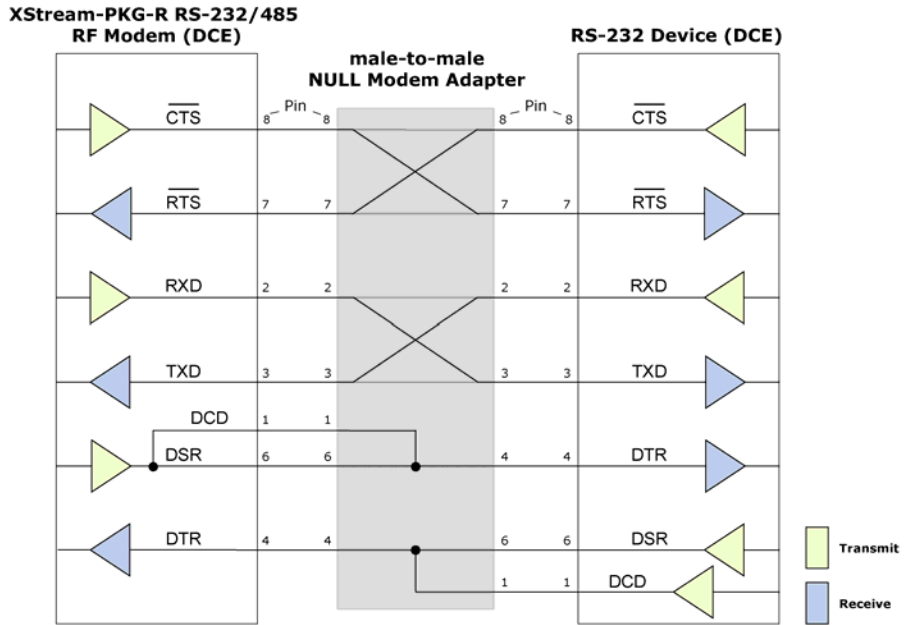

**Sample Wireless Connection: DTE ↔ DCE ⚡ DCE ↔ DCE**

Figure 2.5. Typical wireless link between DTE and DCE devices



## RS-485 (2-wire) Operation

### DIP Switch Settings and Pin Signals

Figure 2.6.  
RS-485 (2-wire) Half-Duplex  
DIP Switch Settings

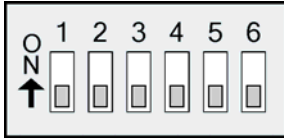

Figure 2.8.  
RS-485 (2-wire) with Termination (optional)



Termination is the 120 Ω resistor between T+ and T-.

DIP Switch settings are read and applied only while powering-on.

Figure 2.7.  
Pins used on the female RS-232 (DB-9)  
Serial Connector

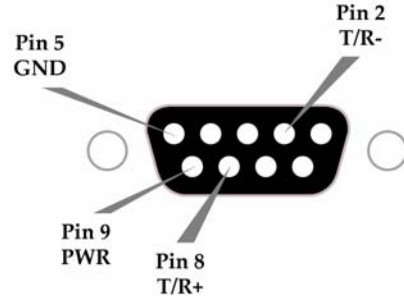

Note: Refer to Figures 2.15 & 2.16 for RJ-45 connector pin designations used in RS-485/422 environments.

Table 2.2. RS-485 (2-wire half-duplex) Signals and their implementations on the XStream RF Modem

DB-9 Pin	RS-485 Name	Description	Implementation
2	T/R- (TRA)	Negative Data Line	Transmit serial data to and from the XStream RF Modem
5	GND	Ground Signal	Ground
8	T/R+ (TRB)	Positive Data Line	Transmit serial data to and from the XStream RF Modem
9	PWR	Power	Optional power input that is connected internally to the front power connector
1, 3, 4, 6, 7			not used

### Wiring Diagram: RS-485 (2-wire) Half-Duplex

Figure 2.9. XStream RF Modem in an RS-485 (2-wire) half-duplex environment

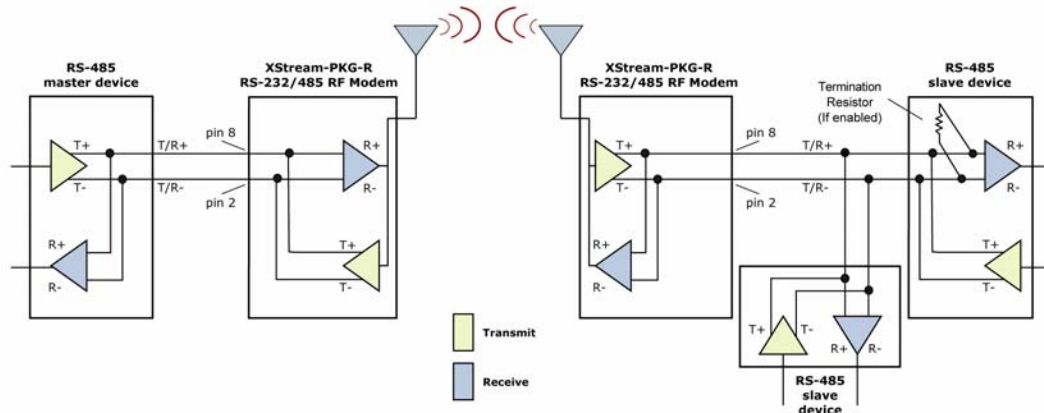

## RS-485 (4-wire) & RS-422 Operation

### DIP Switch Settings and Pin Signals

Figure 2.10.  
RS-485 (4-wire) and RS-422  
DIP Switch Settings

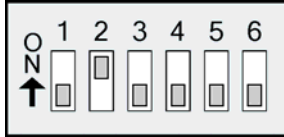

Figure 2.12.  
RS-485 (4-wire) & RS-422 with Termination (optional)



Termination is the 120 Ω resistor between T+ and T-.

DIP Switch settings are read and applied only while powering-on.

Figure 2.11.  
Pins used on the female RS-232 (DB-9)  
Serial Connector

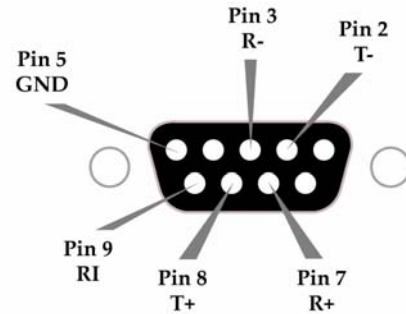
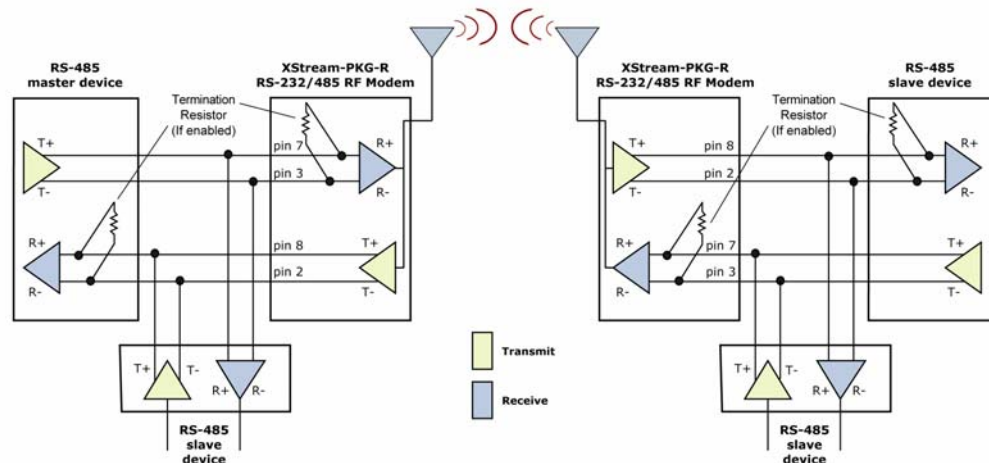

Table 2.3. RS-485/422 (4-wire) Signals and their implementations with the XStream-PKG-R RF Modem

DB-9 Pin	RS-485/422 Name	Description	Implementation
2	T- (TA)	Transmit Negative Data Line	Serial data sent from the XStream RF Modem
3	R- (RA)	Receive Negative Data Line	Serial data received by the XStream RF Modem
5	GND	Signal Ground	Ground
7	R+ (RB)	Receive Positive Data Line	Serial data received by the XStream RF Modem
8	T+ (TB)	Transmit Positive Data Line	Serial data sent from the XStream RF Modem
9	PWR	Power	Optional power input that is connected internally to the front power connector
1, 4, 6			not used

### Wiring Diagram: RS-485 (4-wire) Half-Duplex

Figure 2.13. XStream RF Modem in an RS-485 (4-wire) environment



**Wiring Diagram: RS-422**

**Figure 2.14. XStream RF Modem in an RS-485 (4-wire) environment**

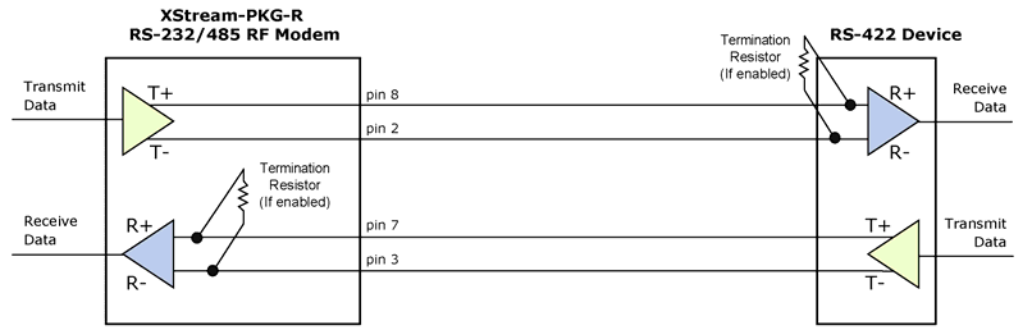

**RS-485/422 Connection Guidelines**

The RS-485/422 protocol provides a solution for wired communications that can tolerate high noise and push signals over long cable lengths. RS-485/422 signals can communicate as far as 4000 feet (1200 m). RS-232 signals are suitable for cable distances up to 100 feet (30.5 m).

RS-485 offers multi-drop capability in which up to 32 nodes can be connected. The RS-422 protocol is used for point-to-point communications.

**Suggestions for integrating the XStream Modem with the RS-485/422 protocol:**

1. When using Ethernet twisted pair cabling: Select wires so that T+ and T- are connected to each wire in a twisted pair. Likewise, select wires so that R+ and R- are connected to a twisted pair. (For example, tie the green and white/green wires to T+ and T-.)
2. For straight-through Ethernet cable (not cross-over cable) – The following wiring pattern works well: Pin3 to T+, Pin4 to R+, Pin5 to R-, Pin6 to T-
3. Note that the connecting cable only requires 4 wires (even though there are 8 wires).
4. When using phone cabling (RJ-11) – Pin2 in the cable maps to Pin3 on opposite end of cable and Pin1 maps to Pin4 respectively.

**Figure 2.15. Male (yellow) DB-9 to RJ-45 Adapters**

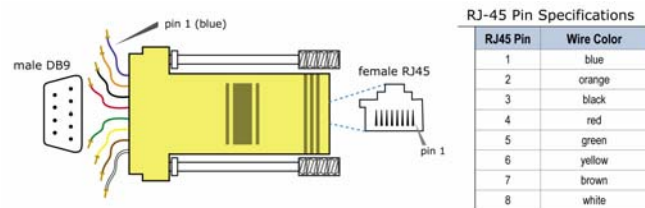

**Figure 2.16. Female (green) DB-9 to RJ-45 Adapters**

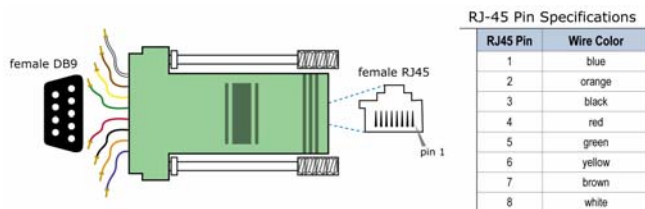

An RS-232 Accessories Kit is available that includes connectors that facilitate RS-232/485/422 and other serial communications. Refer to the Development Guide in Appendix B for information concerning the connectors and tools included in the kit.

# 3. RF Operation

## Serial Communications

### RS-232 and RS-485/422 Data Flow

Devices that have a UART interface can connect directly through the pins of the XStream Modem as is shown in the figure below.

Figure 3.1. System Data Flow Diagram in a UART-interfaced environment

(Low-asserted signals distinguished with horizontal line over signal name.)

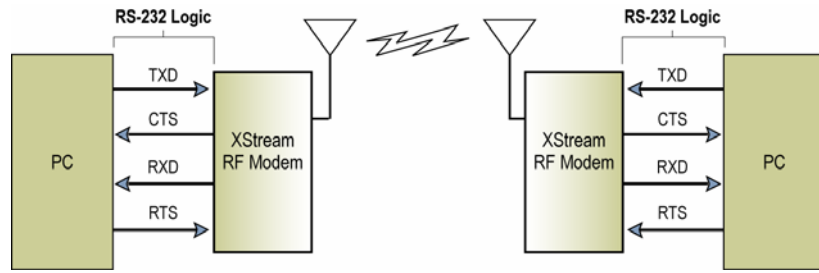

### Host and RF Modem I/O Settings

Serial communications between a host and an XStream RF Modem are dependent upon having matching baud rate, parity, stop bit & number of data bits settings. Refer to the table below to ensure host serial port settings match those of the XStream RF Modem.

Table 3.1. Parameter values critical to serial communications between the RF Modem and host

Parameter Setting	XStream RF Modem Default Parameter Value
Baud (Serial Data Rate)	9600 bps or 19200 baud (Factory-set RF data rates)
Number of Data Bits	8 (NB parameter = 0)
Parity	None (NB parameter = 0)
Number of Stop Bits	1 (NB parameter = 0)

Both the XStream RF Modem and host (PC) settings can be viewed and adjusted using MaxStream’s proprietary X-CTU Software. Use the “PC Settings” tab to configure host settings. Use the “Terminal” or “Modem Configuration” tabs to configure the RF Modem settings. Refer to the Advanced Programming sections for more information.

## Flow Control

Figure 3.2. Internal Data Flow Diagram

(The five most commonly-used pin signals are shown.)

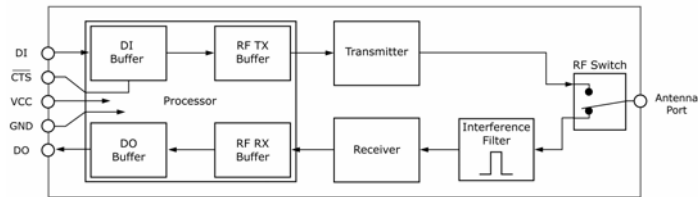

### DI (Data In) Buffer and Flow Control

When serial data enters the XStream Modem through the DI Pin, then the data is stored in the DI Buffer until it can be transmitted.

When the RO parameter threshold is satisfied (refer to Transmit Mode section and command descriptions for more information), the modem attempts to initialize an RF connection. If the modem is already receiving RF data, the serial data is stored in the modem's DI Buffer. If the DI buffer becomes full, hardware or software flow control must be implemented in order to prevent overflow (loss of data between the host and XStream RF Modem).

#### Two cases in which the DI Buffer may become full and possibly overflow:

1. If the serial interface data rate is set higher than the RF data rate of the modem, the modem will receive data from the host faster than it can transmit the data over-the-air.
2. If the modem is receiving a continuous stream of RF data or if the modem is monitoring data on a network, any serial data that arrives on the DI pin is placed in the DI Buffer. The data in the DI buffer will be transmitted over-the-air when the modem no longer detects RF data in the network.

#### How to eliminate the need for flow control:

1. Send messages that are smaller than the DI buffer size. The size of the DI buffer varies according to the packet size and parity setting used.
2. Interface at a lower baud rate (BD Command) than the fixed RF data rate.

**Hardware Flow Control (CTS).** When the DI buffer is 17 bytes away from being full; by default, the modem de-asserts (high)  $\overline{\text{CTS}}$  to signal to the host device to stop sending data [refer to FT (Flow Control Threshold) and CS (DO2 Configuration) Commands].  $\overline{\text{CTS}}$  is re-asserted after the DI Buffer has 34 bytes of memory available.

**Software Flow Control (XON).** XON/XOFF software flow control can be enabled using the FL (Software Flow Control) Command. This option only works with ASCII data.

### DO (Data Out) Buffer and Flow Control

When RF data is received, the data enters the DO buffer and is then sent out the serial port to a host device. Once the DO Buffer reaches capacity, any additional incoming RF data is lost.

#### Two cases in which the DO Buffer may become full and possibly overflow:

1. If the RF data rate is set higher than the interface data rate of the modem, the modem will receive data from the transmitting modem faster than it can send the data to the host.
2. If the host does not allow the modem to transmit data out from the DO buffer because of being held off by hardware or software flow control.

**Hardware Flow Control (RTS).** If  $\overline{\text{RTS}}$  is enabled for flow control (RT Parameter = 2), data will not be sent out the DO Buffer as long as  $\overline{\text{RTS}}$  is de-asserted.

**Software Flow Control (XOFF).** XON/XOFF software flow control can be enabled using the FL (Software Flow Control) Command. This option only works with ASCII data.

## Modes of Operation

XStream RF Modems operate in five modes.

**Figure 3.3. XStream Modes of Operation**

Modem can only be in one mode at a time.

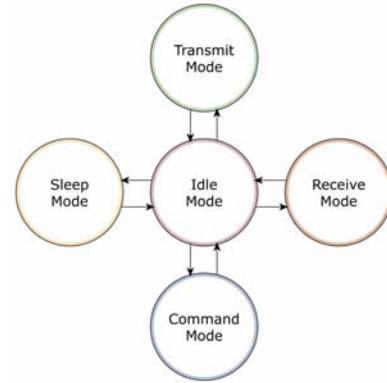

### Idle Mode

When not receiving or transmitting data, the modem is in Idle Mode. The modem uses the same amount of power in Idle Mode as it does in Receive Mode.

The modem shifts into the other modes of operation under the following conditions:

- Serial data is received in the DI Buffer (Transmit Mode)
- Valid RF data is received through the antenna (Receive Mode)
- Command Mode Sequence is issued (Command Mode)
- Sleep Mode condition is met (Sleep Mode)

After responding to any of the preceding conditions, the modem automatically transitions back into Idle Mode.

### Transmit Mode

When the first byte of serial data is received from the UART in the DI buffer, the modem attempts to shift to Transmit Mode and initiate an RF connection with other modems.

**Figure 3.4. Transmission of Data →**

Once in Transmit Mode, the modem initializes a communications channel. Channel initialization is the process of sending an RF initializer that synchronizes receiving modems with the transmitting modem. When streaming multiple RF packets, the RF Initializer is only sent in front of the first packet. During channel initialization, incoming serial data accumulates in the DI buffer.

After the channel is initialized, data in the DI buffer is grouped into packets (up to 64 bytes in each packet) and is transmitted. The modem continues to transmit data packets until the DI buffer is empty. Once transmission is finished, the modem returns to Idle Mode. This progression is shown in Figure 3.4.

As the transmitting modem nears the end of the transmission, it inspects the DI buffer to see if more data exists to be transmitted. This could be the case if more bytes arrived from the host after the transmission began. If more data is pending, the transmitting modem assembles a subsequent packet for transmission.

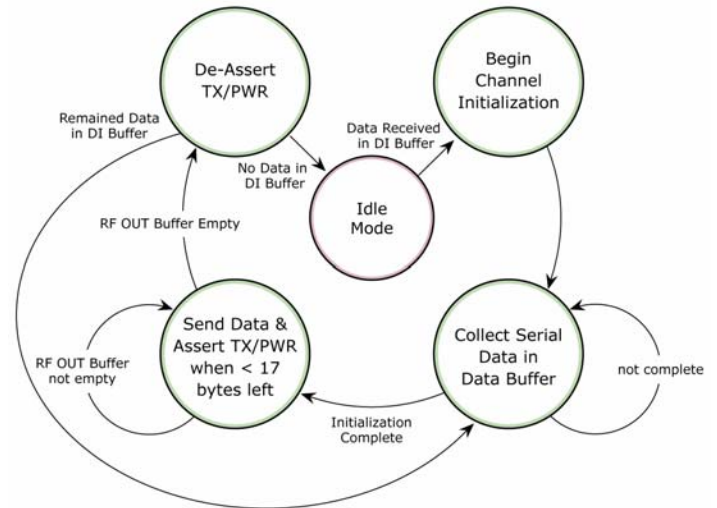

## RF Packet

The RF packet is the sequence of data used for communicating information between MaxStream Modems. An RF Packet consists of an RF Initializer and RF Data.

Figure 3.5. RF Packet Components

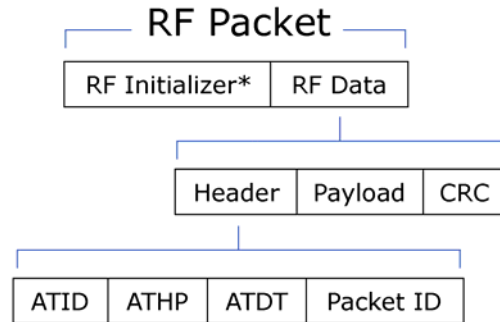

\* When streaming multiple RF packets, the RF Initializer is only sent in front of the first packet.

### RF Initializer

An RF initializer is sent each time a new connection sequence begins. The RF initializer contains channel information that notifies receiving modems of information such as the hopping pattern used by the transmitting modem. The first transmission always sends an RF initializer.

An RF initializer can be of various lengths depending on the amount of time determined to be required to prepare a receiving modem. For example, a wake-up initializer is a type of RF initializer used to wake remote modems from Sleep Mode (Refer to the FH, LH, HT and SM Commands for more information). The length of the wake-up initializer should be longer than the length of time remote modems are in cyclic sleep.

### Header

The header contains network addressing information that is used to filter incoming RF data. The receiving modem checks for matching a VID, Hopping Channel and Destination Address. Data that does not pass through all three network filter layers is discarded.

Figure 3.6. Network Layers Contained in the Header

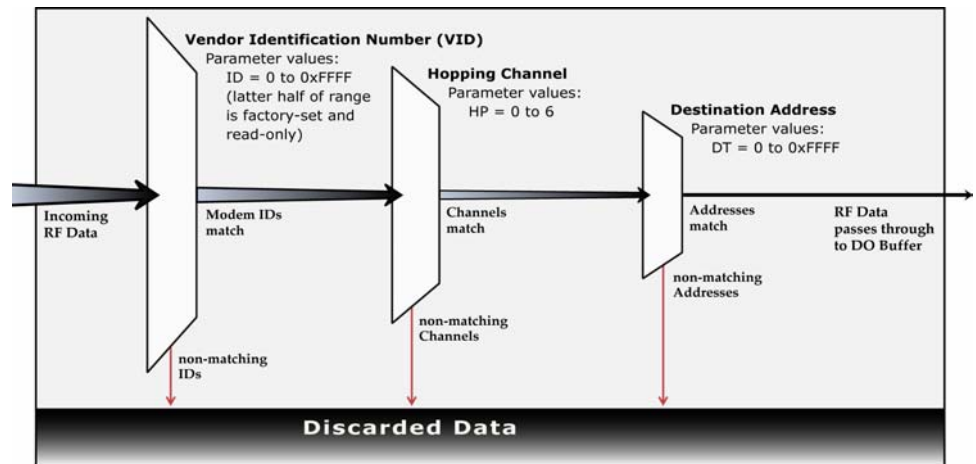

### CRC (Cyclic Redundancy Check)

To verify data integrity and provide built-in error checking, a 16-bit CRC (Cyclic Redundancy Check) is computed for the transmitted data and attached to the end of each RF packet. On the receiving end, the receiving modem computes the CRC on all incoming RF data. Received data that has an invalid CRC is discarded [Refer to Receive Mode section, next page].

## Receive Mode

If a modem detects RF data while operating in Idle Mode, the modem transitions into Receive Mode to start receiving RF packets.

**Figure 3.7. Receive Mode Data Flow →**

After a packet is received, the modem checks the CRC (cyclic redundancy check) to ensure that the data was transmitted without error. If the CRC data bits on the incoming packet are invalid, the packet is discarded. If the CRC is valid, the packet proceeds to the DO Buffer.

The modem returns to Idle Mode after valid RF data is no longer detected or after an error is detected in the received RF data. If serial data is stored in the DI buffer while the modem is in Receive Mode, the serial data will be transmitted after the modem is finished receiving data and returns to Idle Mode.

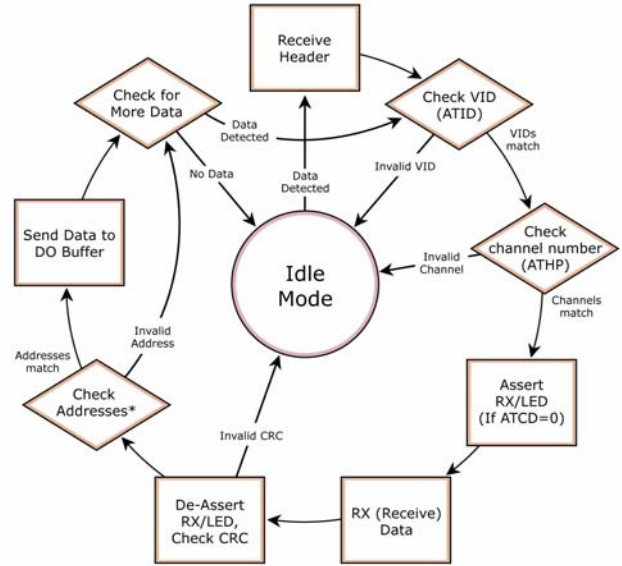

## Sleep Mode

Sleep Modes enable the XStream Modem to operate at minimal power consumption when not in use. Three Sleep Mode options are available:

- **Pin Sleep** (Host Controlled)
- **Serial Port Sleep** (Wake on Serial Port activity)
- **Cyclic Sleep** (Wake on RF activity)

For the modem to transition into Sleep Mode, the modem must have a non-zero SM (Sleep Mode) Parameter and one of the following must occur:

1. The modem is idle (no data transmission or reception) for a user-defined period of time [Refer to ST (Time before Sleep) Command].
2. SLEEP pin is asserted (only for Pin Sleep option).

In Sleep Mode, the modem will not transmit or receive data until the modem first transitions to Idle Mode. All Sleep Modes are enabled and disabled using SM Command. Transitions into and out of Sleep Modes are triggered by various mechanisms as shown in the table below.

**Table 3.2. Summary of Sleep Mode Configurations**

Sleep Mode Setting	Transition into Sleep Mode	Transition out of Sleep Mode	Related Commands	Typical Power Consumption
Pin Sleep (SM = 1)	A microcontroller can shut down and wake modems by asserting (high) SLEEP pin. Note: The modem will complete a transmission or reception even if Pin Sleep is activated.	De-assert SLEEP pin.	SM	< 1 mA
Serial Port Sleep (SM = 2)	Automatic transition to Sleep Mode occurs after a user-defined period of inactivity (no transmitting or receiving of data). The period of activity is defined using the ST (Time before Sleep) Command.	When serial byte is received on the DI pin.	SM, ST	4.5 mA
Cyclic Sleep (SM = 3-8)	Automatic transition to Sleep Mode occurs in cycles as defined by the SM (Sleep Mode) Command. Note: The cyclic sleep time interval must be shorter than the "Wake-up Initializer Timer" (set by LH Command).	After the cyclic sleep time interval elapses. Note: Modem can be forced into Idle Mode if PW (Pin Wake-up) Command is issued.	SM, ST, HT, LH, PW	1.2 mA when sleeping

For more information about Sleep Modes, refer to the individual commands listed in "Related Commands" column of the table. SM Command is the best starting point for implementing sleep mode configurations.

## Command Mode

To modify or read modem parameters, the modem must first enter into Command Mode, the state in which incoming characters are interpreted as commands. Two command types are available for programming the modem:

- AT Commands
- Binary Commands

For modified parameter values to persist in the modem registry, changes must be saved to non-volatile memory using WR (Write) Command. Otherwise, parameters are restored to previously saved values when the modem is powered off and then on again.

### AT Commands

#### To Enter AT Command Mode:

1. Send the 3-character command sequence “+++” and observe guard times before and after the command characters. [Refer to “Default AT Command Mode Sequence” below.] The “Terminal” tab (or other serial communications software) of the X-CTU Software can be used to enter the sequence.  
[OR]
2. Assert (low) the `CONFIG` pin and turn the power going to the modem off and back on. This result can be achieved by keeping the configuration switch pressed while turning off, then on again the power supplying the RF Modem)

Default AT Command Mode Sequence (for transition to Command Mode):

- No characters sent for one second [refer to BT (Guard Time Before) Command]
- Input three plus characters (“+++”) within one second [refer to CC (Command Sequence Character) Command.]
- No characters sent for one second [refer to AT (Guard Time After) Command.]

#### To Send AT Commands:

Send AT commands and parameters using the syntax shown below:

Figure 3.8. Syntax for sending AT Commands

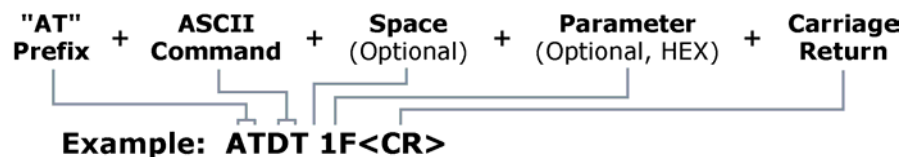

NOTE: To read a parameter value stored in a register, leave the parameter field blank.

The preceding example would change the modem Destination Address to “1F”. To store the new value to non-volatile (long term) memory, the Write (ATWR) Command must follow.

**System Response.** When a command is sent to the modem, the modem will parse and execute the command. Upon successful execution of a command, the modem returns an “OK” message. If execution of a command results in an error, the modem returns an “ERROR” message.

#### To Exit AT Command Mode:

1. Send ATCN (Exit Command Mode) Command.  
[OR]
2. If no valid AT Commands are received within the time specified by CT (Command Mode Timeout) Command, the Modem automatically returns to Idle Mode.

For examples that illustrate the steps of programming the modem using AT Commands, refer to the Advanced Programming [p19] chapter.

## Binary Commands

Sending and receiving register values using binary commands is the fastest way to change the operating parameters of the modem. Binary commands are used most often to sample the signal strength (RS register) and/or error counts or change modem address and channels for polling systems when a quick response is necessary. Since the sending and receiving register values takes place through the same serial data path as 'live' data (received RF payload), interference between the two can be a concern.

Common questions about using binary command mode:

- What are the implications of asserting CMD in any of the various states while live data is being sent or received?
- Specifically, is there a minimum time delay after serial data is sent before which we can assert CMD and send a command?
- Is a delay required after CMD is de-asserted before we can send normal data?
- How can I know if data being received is the response from a command or live data?

Answers: The CMD line can be asserted to send a command to the radio anytime during transmission or reception of data. Note that the status of the CMD signal is only checked at the end of the stop bit as the byte is shifted into the serial port. If the command is sent in the middle of a stream of payload data to be transmitted, the command will essentially be executed in the order it is received. If the radio is continuously receiving data, the radio will wait for a break in the received data before executing the command. The signal will frame the response coming from the binary command request (see graphic below).

The CMD pin must be asserted in order to send binary commands to an XStream Modem. CMD can be asserted to recognize commands anytime during transmission or reception of data. A minimum time delay of 100 μs (after the stop bit of the command byte has been sent) must be observed before CMD pin can be de-asserted. The command executes after all parameters associated with the command have been sent. If all parameters are not received within 0.5 seconds, the modem aborts the command and returns to Idle Mode. Note: When parameters are sent, they are always two bytes long with the least significant byte sent first.

Commands can be queried for their current value by sending the command logically ORed with the value 0x80 (hexadecimal) with CMD asserted. When the binary value is sent (with no parameters), the current value of the command parameter is sent back through the DO pin.

Figure 3.9. Binary Command Write then Read

- Signal #4 is CMD
- Signal #1 is the DIN signal to the radio
- Signal #2 is the DOUT signal from the radio
- Signal #3 is  $\overline{\text{CTS}}$

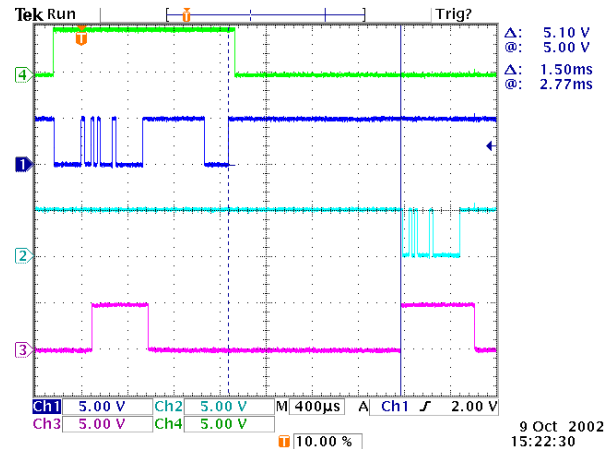

A value was written to a register and then read out to verify it. While not in the middle of other received data, note that the  $\overline{\text{CTS}}$  signal outlines the data response out of the modem.

**IMPORTANT:** For the XStream Modem to recognize a binary command, RT (DI2 Configuration) Command must be issued. If binary programming is not enabled (RT ≠ 1), the modem will not recognize that the CMD pin is asserted and therefore will not recognize the data as binary commands.

# 4. Advanced Programming

## Automatic DIP Switch Configurations

Each time the RF Modem is powered-on, intelligence on the XIB-R Interface Board (RS-232/485 interfacing board located inside the RF Modem) sends AT Commands that program the RF Modem based on positions of the DIP Switch. Automatic configurations that take place during the power-on sequence affect stored RF Modem parameter values as shown in the tables below.

Figure 4.1. RF Modem DIP Switch

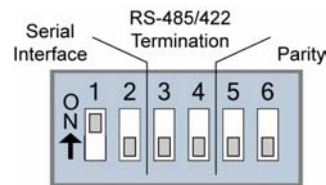

Table 4.1. RF Modem Power-up Options (J7 jumper and Config Switch)

Condition	Behavior
If J7 is populated	Processor is disabled and AT Commands are not sent to the RF Modem
If Config Switch is pressed	Processor is disabled and RF Modem enters into AT Command Mode
If J7 is NOT populated and Config Switch is NOT pressed	Execute logic as shown in table below.

Table 4.2. AT Commands Sent as result of DIP Switch Settings (SW = DIP Switch)

Condition	Behavior
Restore Default Parameter Values of the RF Modem	
If SW1 & SW2 are ON (up)	AT Commands sent: ATRE (Restore Defaults) Command ATWR (Write) Command
Serial Interfacing Options	
If SW1 is ON (up)	AT Commands sent: ATCS 0 (RS-232 Operation: CTS function for CTS line, DB-9 pin 8) ATCD 2 (DO3 - RX LED = low)
If SW1 is OFF (down)	AT Commands sent: ATCS 3 (RS-485 or RS-422 Operation) ATCD 2 (DO3 - RX LED = low)
Parity Options	
If SW5 & SW6 are OFF (down)	AT Commands sent: ATNB 0 (parity = none)
If SW5 is OFF (down) & SW6 is ON (up)	AT Commands sent: ATNB 1 (parity = even)
If SW5 is ON (up) & SW6 is OFF (down)	AT Commands sent: ATNB 2 (parity = odd)
If SW5 is ON (up) & SW6 is ON (up)	AT Commands sent: ATNB 5 (parity = 9th bit data over-the-air, v4.30 only)
Exit AT Command Mode	
Always	AT Commands sent: ATCN (Exit AT Command Mode)

**IMPORTANT:** To avoid overwriting previously stored custom configurations (due to the automatic configurations that take place each time the RF Modem is powered-on), it is necessary to disable a processor located on the XIB-R interface board. To disable the processor, populate the J7 jumper of the XIB-R Interface Board. By default, J7 is not populated.

## Programming the Modem

For information about entering and exiting AT and Binary Command Modes, refer to the Command Mode section [p17].

### AT Command Examples

MaxStream has provided X-CTU software for programming the modem using an extensive list of AT Commands. The X-CTU software provides an interface that is divided into four tabs that facilitate the following functions:

- PC Settings tab - Setup PC serial port to interface with an XStream RF Modem
- Range Test tab – Test XStream RF Modem's range in varying environments
- Terminal tab – Configure and read XStream RF Modem parameters using AT Commands
- Modem Configuration tab – Configure and read RF Modem parameters

#### To install the X-CTU Software:

Double-click the "setup\_X-CTU.exe" file located in the MaxStream CD or under the "Downloads" section of the following web page: [www.maxstream.net/helpdesk/](http://www.maxstream.net/helpdesk/). Then follow the prompts of the installation screens.

### PC Settings Tab

As stated in the Serial Communications section; in order to communicate data to the RF modem through the PC, baud (serial data rate), data bit, parity and stop bit settings on the PC serial port must match those of the RF modem. The PC Settings tab provides a software user interface that facilitates the modification of PC serial port setting.

#### PC Setup

1. Set the DIP Switch to RS-232 mode. Switch 1 is ON (up) and the remaining 5 switches are OFF (down).
2. Connect the male DB-9 connector of the PC with the female DB-9 connector of the RF modem using an RS-232 cable.
3. Power the RF modem through the power connector.
4. Launch X-CTU Software and select the PC Settings tab; then select parameter values from the dropdown lists that match the current parameter values of the RF modem. [Refer to Table 3.1 on p12 for more information.]

Figure 4.2. RF Modem Configurations through a Serial Cable

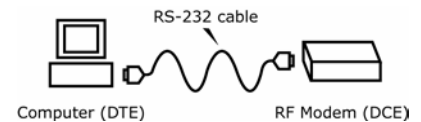

### Terminal Tab

A terminal program has been built into the X-CTU software and is located under the Terminal tab. The Terminal tab provides an easy-to-use interface for programming the modem.

**Multiple AT Commands.** Multiple AT commands can be entered on one line with one carriage return at the end of the line. Each command must be delimited by a comma (spaces in between are optional). The "AT" prefix is only sent before the first command and should not be included with subsequent commands in a line.

**System Response.** When a command is sent to the modem, the modem will parse and execute the command. Upon successful execution of a command, the modem returns an "OK" message. If execution of a command results in an error, the modem returns an "ERROR" message.

**EXAMPLE: Restore RF Modem Defaults using the Terminal tab:**

Both of the following examples change the XStream Modem’s destination address to 0x1A0D (6669d) and save the new address to non-volatile memory.

Method 1 (One line per command)

Issue AT Command	System Response
+++	OK<CR> (Enter into AT Command Mode)
ATRE <Enter>	OK<CR> (Restore modem default parameter values)
ATWR <Enter>	OK<CR> (Write new values to non-volatile memory)
ATCN <Enter>	OK<CR> (Exit AT Command Mode)

Method 2 (Multiple commands on one line)

Issue AT Command	System Response
+++	OK<CR>
ATRE, WR, CN <Enter>	OK<CR>

NOTE: Default parameter values of the RF Modem can also be restored by selecting the “Restore Defaults” button located on the Modem Configuration tab.

**Modem Configuration tab**

While XStream RF Modems operate out-of-box without configuration, the “Modem Configuration” tab of the X-CTU software can be used to activate advanced functions. The following example illustrates use of the most commonly used features of the Modem Configuration tab.

**EXAMPLE: Read Parameters & Restore Defaults using the Modem Configuration tab:**

The following steps show how to read currently stored modem parameter values; then restore the modem parameters to their factory-default states.

1. Open the X-CTU program (Start --> Programs --> MaxStream --> X-CTU):
2. Under the “PC Settings” tab, select the PC Serial Com Port from the dropdown list that will be used to connect to the RF Modem.
3. Select a “Baud rate” to match the default RF data rate of the RF Modem. Use default values for all other fields.
4. Select the “Modem Configuration” tab.
5. Select the “Read” button to read currently stored parameter values of the modem.
6. Select the “Restore” button to restore factory-default parameter values.
7. Select the “Write” button to save default values to non-volatile memory.

**Binary Command Example**

**To Send Binary Commands:**

Example: Use binary commands to change the XStream Modem’s destination address to 0x1A0D and save the new address to non-volatile memory.

1. RT Command must be set to “1” in AT Command Mode to enable binary programming.
2. Assert CMD (Pin is driven high). (Enter Binary Command Mode)
3. Send Bytes: 00 (Send DT (Destination Address) Command)  
 0D (Least significant byte of parameter bytes)  
 1A (Most significant byte of parameter bytes)  
 08 (Send WR (Write) Command)
4. De-assert CMD (Pin is driven low). (Exit Binary Command Mode)

Note:  $\overline{CTS}$  is high when command is being executed. Hardware flow control must be disabled as  $\overline{CTS}$  will hold off parameter bytes.

## Command Descriptions (short)

**Table 4.1 XStream Commands**

(The XStream Modem expects numerical values in hexadecimal. “d” denotes decimal equivalent.)

AT Command	Binary Command	AT Command Name	Range	Command Category	# Bytes Returned	Factory Default
AT	0x05 (5d)	Guard Time After	0x02 – 0xFFFF [x 100 msec]	Command Mode Options	2	0x0A (10d)
BD	0x15 (21d)	Baud Rate	0 – 6	Serial Interfacing	1	RF data rate
BT	0x04 (4d)	Guard Time Before	0 – 0xFFFF [x 100 msec]	Command Mode Options	2	0x0A (10d)
CC	0x13 (19d)	Command Sequence Character	0x20 – 0x7F	Command Mode Options	1	0x2B (“+”)
CD v 4.29D*	0x28 (40d)	DO3 Configuration	0 - 2	Serial Interfacing	1	0
CN	0x09 (9d)	Exit AT Command Mode	-	Command Mode Options	-	-
CS v 4.27D*	0x1F (31d)	DO2 Configuration	0 – 4	Serial Interfacing	1	0
CT	0x06 (6d)	Command Mode Timeout	0x02 – 0xFFFF [x 100 msec]	Command Mode Options	2	0xC8 (200d)
DT	0x00 (0d)	Destination Address	0 – 0xFFFF	Networking	2	0
E0	0x0A (10d)	Echo Off	-	Command Mode Options	-	-
E1	0x0B (11d)	Echo On	-	Command Mode Options	-	-
ER	0x0F (15d)	Receive Error Count	0 – 0xFFFF	Diagnostics	2	0
FH	0x0D (13d)	Force Wake-up Initializer	-	Sleep (Low Power)	-	-
FL	0x07 (7d)	Software Flow Control	0 – 1	Serial Interfacing	1	0
FT v 4.27B*	0x24 (36d)	Flow Control Threshold	0 – 0xFF [bytes]	Serial Interfacing	2	varies
GD	0x10 (16d)	Receive Good Count	0 – 0xFFFF	Diagnostics	2	0
HP	0x11 (17d)	Hopping Channel	0 – 6	Networking	1	0
HT	0x03 (3d)	Time before Wake-up Initializer	0 – 0xFFFF [x 100 msec]	Sleep (Low Power)	2	0xFFFF
ID v 4.27C*	0x27 (39d)	Modem VID	0 – 0xFFFF [Read-only]	Networking	2	-
LH	0x0C (12d)	Wake-up Initializer Timer	0 – 0xFF [x 100 msec]	Sleep (Low Power)	1	1
MK	0x12 (18d)	Address Mask	0 – 0xFFFF	Networking	2	0xFFFF
NB v 4.27B*	0x23 (35d)	Parity	0 – 4	Serial Interfacing	1	0
PC v 4.22*	0x1E (30d)	Power-up Mode	0 – 1	Command Mode Options	1	0
PW v 4.22*	0x1D (29d)	Pin Wake-up	0 – 1	Sleep (Low Power)	1	0
RE	0x0E (14d)	Restore Defaults	-	(Special)	-	-
RN v 4.22*	0x19 (25d)	Delay Slots	0 – 0xFF [slots]	Networking	1	0
RO v 4.2AA*	0x21 (33d)	Packetization Timeout	0 – 0xFFFF [x 200 µsec]	Serial Interfacing	2	0
RP v 4.2AA*	0x22 (34d)	RSSI PWM Timer	0 - 0x7F [x 100 msec]	Diagnostics	1	0
RR v 4.22*	0x18 (24d)	Retries	0 – 0xFF	Networking	1	0
RS v 4.22*	0x1C (28d)	RSSI	0x06 – 0x36 [Read-only]	Diagnostics	1	-
RT	0x16 (22d)	DI2 Configuration	0 - 2	Serial Interfacing	1	0
SH v 4.27C*	0x25 (37d)	Serial Number High	0 – 0xFFFF [Read-only]	Diagnostics	2	-
SL v 4.27C*	0x26 (38d)	Serial Number Low	0 – 0xFFFF [Read-only]	Diagnostics	2	-
SM	0x01 (1d)	Sleep Mode	0 – 8	Sleep (Low Power)	1	0
ST	0x02 (2d)	Time before Sleep	0x10 – 0xFFFF [x 100 msec]	Sleep (Low Power)	2	0x64 (100d)
SY	0x17 (23d)	Time before Initialization	0 – 0xFF [x 100 msec]	Networking	1	0 (disabled)
TR v 4.22*	0x1B (27d)	Transmit Error Count	0 – 0xFFFF	Diagnostics	2	0
TT v 4.22*	0x1A (26d)	Streaming Limit	0 – 0xFFFF [0 = disabled]	Networking	2	0xFFFF
VR	0x14 (20d)	Firmware Version	0 x 0xFFFF [Read-only]	Diagnostics	2	-
WR	0x08 (8d)	Write	-	(Special)	-	-

\* Firmware version in which command and parameter options were first supported.

NOTE: AT Commands issued without a parameter value will return the currently stored parameter.

## Command Descriptions (long)

Commands in this section are listed alphabetically. Command categories are designated between the "< >" symbols that follow each command title. XStream Modems expect numerical values in hexadecimal and those values are designated by a "0x" prefix.

### AT (Guard Time After) Command

<Command Mode Options> AT Command is used to set the time-of-silence that follows the command sequence character (CC Command). By default, AT Command Mode will activate after one second of silence.

The AT Command Mode Sequence used to enter AT Command Mode is as follows:

- No characters sent for 1 second [BT (Guard Time Before) Command]
- Send three plus characters "+++" [CC (Command Sequence Character) Command]
- No characters sent for 1 second [AT (Guard Time After) Command]

All of the values in this sequence can be adjusted. AT Command is used to adjust the period of silence that follows the command sequence character.

AT Command: ATAT

Binary Command: 0x05 (5 decimal)

Parameter Range: 0x02 - 0xFFFF  
[x 100 milliseconds]

Number of bytes returned: 2

Default Parameter Value: 0x0A (10 decimal)

Related Commands: BT (Guard Time Before), CC (Command Sequence Character)

### BD (Baud Rate) Command

<Serial Interfacing> BD Command allows the user to adjust the UART I/O serial data rate and thus modify the rate at which serial data is sent to the modem. The new baud rate does not take effect until the CN (Exit AT Command Mode) Command is issued. The RF data rate is not affected by the BD Command.

Note: If the serial data rate is set to exceed the fixed RF data rate of the XStream modem, CTS flow control may need to be implemented as described in the Pin Signals and Flow Control sections of this manual.

AT Command: ATBD

Binary Command: 0x15 (21 decimal)

Parameter Range: 0 - 6

Parameter Value	BAUD (bps) Configuration
0	1200
1	2400
2	4800
3	9600
4	19200
5	38400
6	57600

Number of bytes returned: 1

Default Parameter Value: Equal to modem's fixed RF data rate.

### BT (Guard Time Before) Command

<Command Mode Options> BT Command is used to set the DI pin silence time that must precede the command sequence character (CC Command) of the AT Command Mode Sequence.

The default sequence used to enter AT Command Mode is as follows:

- No characters sent for 1 second [BT (Guard Time Before) Command]
- Send three plus characters "+++" [CC (Command Sequence Character) Command]
- No characters sent for 1 second [AT (Guard Time After) Command]

All of the values in this sequence can be adjusted.

AT Command: ATBT

Binary Command: 0x04 (4 decimal)

Parameter Range: 0 - 0xFFFF  
[x 100 milliseconds]

Default Parameter Value: 0x0A (10 decimal)

Number of bytes returned: 2

Related Commands: AT (Guard Time After), CC (Command Sequence Character)

### CC (Command Sequence Character) Command

<Command Mode Options> CC Command is used to set the ASCII character to be used between Guard Times of the AT Command Mode Sequence (BT+ CC + AT). The AT Command Mode Sequence activates AT Command Mode (from Idle Mode). The default sequence used to enter AT Command Mode is as follows:

- No characters sent for 1 second [BT (Guard Time Before) Command]
- Send three plus characters “+++” [CC (Command Sequence Character) Command]
- No characters sent for 1 second [AT (Guard Time After) Command]

All of the values in this sequence can be adjusted. CC Command is used to change the command sequence character.

AT Command: ATCC
Binary Command: 0x13 (19 decimal)
Parameter Range: 0x20 – 0x7F
Default Parameter Value: 0x2B (ASCII “+” sign)
Number of bytes returned: 1
Related Commands: AT (Guard Time After), BT (Guard Time Before)

### CD (DO3 Configuration) Command

<Command Mode Options> CD Command is used to redefine the behavior of the DO3/RX LED line.

AT Command: ATCD								
Binary Command: 0x28 (40 decimal)								
Parameter Range: 0 – 2								
<table border="1"> <thead> <tr> <th>Parameter Value</th> <th>Configuration</th> </tr> </thead> <tbody> <tr> <td>0</td> <td>RX LED</td> </tr> <tr> <td>1</td> <td>Default high</td> </tr> <tr> <td>2</td> <td>Default low</td> </tr> </tbody> </table>	Parameter Value	Configuration	0	RX LED	1	Default high	2	Default low
Parameter Value	Configuration							
0	RX LED							
1	Default high							
2	Default low							
Default Parameter Value: 0								
Number of bytes returned: 1								
Minimum Firmware Version Required: 4.29D								

### CN (Exit AT Command Mode) Command

<Command Mode Options> CN Command is used to explicitly exit AT Command Mode.

AT Command: ATCN
Binary Command: 0x09 (9 decimal)

### CS (DO2 Configuration) Command

<Serial Interfacing> CS Command is used to select the behavior of the DO2 pin signal. This output can provide RS-232 flow control, control the TX enable signal (for RS-485 or RS-422 operations), or set the default level for the I/O line passing function.

By default, DO2 provides RS-232  $\overline{\text{CTS}}$  (Clear-to-Send) flow control.

AT Command: ATCS												
Binary Command: 0x1F (31 decimal)												
Parameter Range: 0 – 4												
<table border="1"> <thead> <tr> <th>Parameter Value</th> <th>Configuration</th> </tr> </thead> <tbody> <tr> <td>0</td> <td>RS-232 <math>\overline{\text{CTS}}</math> flow control</td> </tr> <tr> <td>1</td> <td>RS-485 TX enable low</td> </tr> <tr> <td>2</td> <td>high</td> </tr> <tr> <td>3</td> <td>RS-485 TX enable high</td> </tr> <tr> <td>4</td> <td>low</td> </tr> </tbody> </table>	Parameter Value	Configuration	0	RS-232 $\overline{\text{CTS}}$ flow control	1	RS-485 TX enable low	2	high	3	RS-485 TX enable high	4	low
Parameter Value	Configuration											
0	RS-232 $\overline{\text{CTS}}$ flow control											
1	RS-485 TX enable low											
2	high											
3	RS-485 TX enable high											
4	low											
Default Parameter Value: 0												
Number of bytes returned: 1												
Related Commands: RT (DI2 Configuration), TO (DO2 Timeout)												
Minimum Firmware Version Required: 4.27D												

**CT (Command Mode Timeout) Command**

<Command Mode Options> CT Command sets the amount of time before AT Command Mode terminates automatically. After a CT time of inactivity, the modem exits AT Command Mode and returns to Idle Mode. AT Command Mode can also be exited manually using CN (Exit AT Command Mode) Command.

AT Command: ATCT  
 Binary Command: 0x06 (6 decimal)  
 Parameter Range: 0x02 – 0xFFFF  
 [x 100 milliseconds]  
 Default Parameter Value: 0xC8 (200 decimal, 20 seconds)  
 Number of bytes returned: 2

**DT (Destination Address) Command**

<Networking> DT Command is used to set the networking address of an XStream Modem. XStream Modems uses three network layers – Vendor Identification Number (ATID), Channels (ATHP), and Destination Addresses (ATDT). DT Command assigns an address to a modem that enables it to communicate only with other modems having the same addresses. All modems that share the same Destination Address can communicate freely with each other. Modems in the same network with a different Destination Address (than that of the transmitter) will listen to all transmissions to stay synchronized, but will not send any of the data out their serial ports.

AT Command: ATDT  
 Binary Command: 0x00  
 Parameter Range: 0 – 0xFFFF  
 Default Parameter Value: 0  
 Number of bytes returned: 2  
 Related Commands: HP (Hopping Channel), ID (Modem VID), MK (Address Mask)

**E0 (Echo Off) Command**

<Command Mode Options> E0 Command turns off character echo in AT Command Mode. By default, echo is off.

AT Command: ATE0  
 Binary Command: 0x0A (10 decimal)

**E1 (Echo On) Command**

<Command Mode Options> E1 Command turns on the echo in AT Command Mode. Each typed character will be echoed back to the terminal when ATE1 is active. E0 is the default.

AT Command: ATE1  
 Binary Command: 0x0B (11 decimal)

**ER (Receive Error Count) Command**

<Diagnostics> Set/Read the receive-error. The error-count records the number of packets partially received then aborted on a reception error. This value returns to 0 after a reset and is not non-volatile (Value does not persist in the modem’s memory after a power-up sequence). Once the “Receive Error Count” reaches its maximum value (up to 0xFFFF), it remains at its maximum count value until the maximum count value is explicitly changed or the modem is reset.

AT Command: ATER  
 Binary Command: 0x0F (15 decimal)  
 Parameter Range: 0 – 0xFFFF  
 Default Parameter Value: 0  
 Number of bytes returned: 2  
 Related Commands: GD (Receive Good Count)

**FH (Force Wake-up Initializer) Command**

<Sleep (Low Power)> FH Command is used to force a Wake-up Initializer to be sent on the next transmit. WR (Write) Command does not need to be issued with FH Command.

AT Command: ATFH  
 Binary Command: 0x0D (13 decimal)

Use only with cyclic sleep modes active on remote modems.

### FL (Software Flow Control) Command

<Serial Interfacing> FL Command is used to configure software flow control. Hardware flow control is implemented with the XStream Modem as the DO2 pin ( $\overline{\text{CTS}}$ ), which regulates when serial data can be transferred to the modem. FL Command can be used to allow software flow control to also be enabled. XON character used is 0x11 (17 decimal). XOFF character used is 0x13 (19 decimal).

AT Command: ATFL

Binary Command: 0x07 (7 decimal)

Parameter Range: 0 – 1

Parameter Value	Configuration
0	Disable software flow control
1	Enable software flow control

Default Parameter Value: 0

Number of bytes returned: 1

### FT (Flow Control Threshold) Command

<Serial Interfacing> FT Command is used to assert  $\overline{\text{CTS}}$  or XOFF software flow control when FT bytes are in the receiving modem DO buffer.

AT Command: ATFT

Binary Command: 0x24 (36 decimal)

Parameter Range: 0 – (Receiving modem DO buffer size minus 0x11 bytes)

Default Parameter Value: Receiving modem DO Buffer size minus 0x11

Number of bytes returned: 2

Minimum Firmware Version Required: 4.27B

### GD (Receive Good Count) Command

<Diagnostics> Set/Read the count of good received RF packets. Parameter value is reset to 0 after every reset and is not non-volatile (Value does not persist in the modem's memory after a power-up sequence). Once the "Receive Good Count" reaches its maximum value (up to 0xFFFF), it remains at its maximum count value until the maximum count value is manually changed or the modem is reset.

AT Command: ATGD

Binary Command: 0x10 (16 decimal)

Parameter Range: 0 – 0xFFFF

Default Parameter Value: 0

Number of bytes returned: 2

Related Commands: ER (Receive Error Count)

### HP (Hopping Channel) Command

<Networking> HP Command is used to set the modem's hopping channel number. A channel is one of three layers of addressing available to the XStream modem. In order for modems to communicate with each other, the modems must have the same channel number since each network uses a different hopping sequence. Different channels can be used to prevent modems in one network from listening to transmissions of another.

AT Command: ATHP

Binary Command: 0x11 (17 decimal)

Parameter Range: 0 – 6

Default Parameter Value: 0

Number of bytes returned: 1

Related Commands: DT (Destination Address), ID (Modem VID), MK (Address Mask)

### HT (Time before Wake-up Initializer) Command

<Sleep (Low Power)> If any modems within range are running in a “Cyclic Sleep” setting, a wake-up initializer must be used by the transmitting modem for sleeping modems to remain awake [refer to the LH (“Wake-up Initializer Timer”) Command]. When a receiving modem in Cyclic Sleep wakes, it must detect the wake-up initializer in order to remain awake and receive data. The value of HT Parameter tells the transmitter, “After a period of inactivity (no transmitting or receiving) lasting HT amount of time, send a long wake-up initializer”. HT Parameter should be set to match the inactivity timeout [specified by ST (Time before Sleep) Command] used by the receiver(s).

From the receiving modem perspective, after HT time elapses and the inactivity timeout [ST Command] is met, the receiver goes into cyclic sleep. In cyclic sleep, the receiver wakes once per sleep interval to check for a wake-up initializer. When a wake-up initializer is detected, the modem will stay awake to receive data. The wake-up initializer must be longer than the cyclic sleep interval to ensure that sleeping modems detect incoming data. When HT time elapses, the transmitter then knows that it needs to send a long Wake-up Initializer for all receivers to be able to remain awake and receive the next transmission. Matching HT to the time specified by ST on the receiving modem guarantees that all receivers will detect the next transmission.

AT Command: ATHT

Binary Command: 0x03 (3 decimal)

Parameter Range: 0 – 0xFFFF  
[x 100 milliseconds]

Default Parameter Value: 0xFFFF (means that long wake-up initializer will not be sent)

Number of bytes returned: 2

Related Commands: LH (Wake-up Initializer Timer), SM (Sleep Mode), ST (Time before Sleep)

### ID (Modem VID) Command

<Networking> Read the modem’s VID. VID is a MaxStream-specific acronym that stands for “Vendor Identification Number”. This number is factory-set and allows modems with matching VIDs to communicate. Modems with non-matching VIDs will not receive unintended data transmission.

AT Command: ATID

Binary Command: 0x27 (39 decimal)

Parameter Range: 0 – 0xFFFF [read-only]

Number of bytes returned: 2

Minimum Firmware Version Required: 4.27C

### LH (Wake-up Initializer Timer) Command

<Sleep (Low Power)> LH Command adjusts the duration of time for which the RF initializer is sent. When receiving modems are put into Cyclic Sleep Mode, they power-down after a period of inactivity [specified by ST (Time before Sleep) Command] and will periodically awaken and listen for transmitted data. In order for the receiving modems to remain awake, they must detect ~35ms of the wake-up initializer.

LH Command must be used whenever a receiver is operating in Cyclic Sleep Mode. This lengthens the Wake-up Initializer to a specific amount of time (in tenths of a second). The Wake-up Initializer Time must be longer than the cyclic sleep time that is determined by SM (Sleep Mode) Command. If the wake-up initializer time were less than the Cyclic Sleep interval, the connection would be at risk of missing the wake-up initializer transmission.

Refer to Figures 4.3 & 4.4 of the SM Command description to view diagrams of correct and incorrect configurations. The images help visualize the importance that the value of LH be greater than the value of SM.

AT Command: ATLH

Binary Command: 0x0C (12 decimal)

Parameter Range: 0 – 0xFF  
[x 100 milliseconds]

Default Parameter Value: 1

Number of bytes returned: 1

Related Commands: HT (Time before Wake-up Initializer), SM (Sleep Mode), ST (Time before Sleep)

**MK (Address Mask) Command**

<Networking> MK Command is used to set/read the Address Mask.

All data packets contain the Destination Address of the transmitting modem. When an RF data packet is received, the transmitter’s Destination Address is logically “ANDed” (bitwise) with the Address Mask of the receiver. The resulting value must match the Destination Address or the Address Mask of the receiver for the packet to be received and sent out the modem’s DO serial port. If the “ANDed” value does not match either the Destination Address or the Address Mask of the receiver, the packet is discarded. (All “0” values are treated as “irrelevant” values and are ignored.)

AT Command: ATMK

Binary Command: 0x12 (18 decimal)

Parameter Range: 0 – 0xFFFF

Default Parameter Value: 0xFFFF  
(Destination address (DT parameter) of the transmitting modem must exactly match the destination address of the receiving modem.)

Number of bytes returned: 2

Related Commands: DT (Destination Address), HP (Hopping Channel), ID (Modem VID), MY (Source Address)

**NB (Parity) Command**

<Serial Interfacing> Select/Read parity settings for UART communications.

AT Command: ATNB

Binary Command: 0x23 (35 decimal)

Parameter Range: 0 – 4

Parameter Value	Configuration
0	8-bit (no parity or 7-bit (any parity))
1	8-bit even
2	8-bit odd
3	8-bit mark
4	8-bit space

Default Parameter Value: 0

Number of bytes returned: 1

Minimum Firmware Version Required: 4.27B

**PC (Power-up to AT Mode) Command**

<Command Mode Options> PC Command allows the modem to power-up directly into AT Command Mode from reset or power-on. If PC Command is enabled with SM Parameter set to 1, the DI3 Pin (SLEEP) can be used to enter the modem into AT Command Mode. When the DI3 pin is de-asserted (low), the modem will Wake-up into AT Command Mode. This behavior allows modem DTR emulation.

AT Command: ATPC

Binary Command: 0x1E (30 decimal)

Parameter Range: 0 – 1

Parameter Value	Configuration
0	Power-up to Idle Mode
1	Power-up to AT Command Mode

Default Parameter Value: 0

Number of bytes returned: 1

Minimum Firmware Version Required: 4.22

**PW (Pin Wake-up) Command**

<Sleep (Low Power)> Under normal operation, a modem in Cyclic Sleep Mode cycles from an active state to a low-power state at regular intervals until data is ready to be received. If the PW Parameter is set to 1, the DI3 (SLEEP) Pin can be used to awaken the modem from Cyclic Sleep. If the DI3 Pin is de-asserted (low), the modem will be fully operational and will not go into Cyclic Sleep. Once SLEEP is asserted, the modem will remain active for the period of time specified by ST (Time before Sleep) Command, and will return to Cyclic Sleep Mode (if no data is ready to be transmitted). PW Command is only valid if Cyclic Sleep has been enabled.

AT Command: ATPW

Binary Command: 0x1D (29 decimal)

Parameter Range: 0 - 1

Parameter Value	Configuration
0	Disabled
1	Enabled

Default Parameter Value: 0

Number of bytes returned: 1

Related Commands: SM (Sleep Mode), ST (Time before Sleep)

Minimum Firmware Version Required: 4.22

**RE (Restore Defaults) Command**

<Diagnostics> RE Command restores all configurable parameters to factory default settings. However, RE Command will not write the default values to non-volatile (persistent) memory. Unless the WR (Write) Command is issued after the RE command, the default settings will not be saved in the event of modem reset or power-down.

AT Command: ATRE

Binary Command: 0x0E (14 decimal)

**RN (Delay Slots) Command**

<Networking> RN Command is only applicable if retries have been enabled [RR (Retries) Command], or if forced delays will be inserted into a transmission [see TT (Streaming Limit) Command]. RN Command is used to adjust the time delay that the transmitter inserts before attempting to resend a packet. If the transmitter fails to receive an acknowledgement after sending a packet, it will insert a random number of delay slots (ranging from 0 to (RN minus 1)) before attempting to resend the packet. Each delay slot lasts for a period of 38ms.

AT Command: ATRN

Binary Command: 0x19 (25 decimal)

Parameter Range: 0 - 0xFF [slots]

Default Parameter Value: 0 (no delay slots inserted)

Number of bytes returned: 1

Related Commands: RR (Retries), TT (Streaming Limit)

Minimum Firmware Version Required: 4.22

If two modems attempted to transmit at the same time, the random time delay after packet failure would allow one of the two modems to transmit the packet successfully, while the other would wait until the channel opens up to begin transmission.

**RO (Packetization Timeout) Command**

<Serial Interfacing> RO Command is used to specify/read the time of silence (no bytes received) after which transmission begins. After a serial byte is received and if no other byte is received before the RO timeout, the transmission will start.

AT Command: ATRO

Binary Command: 0x21 (33 decimal)

Parameter Range: 0 - 0xFFFF [x 200 μs]

Default Parameter Value: 0

Number of bytes returned: 2

Minimum Firmware Version Required: 4.2AA

**RP (RSSI PWM Timer) Command**

<Diagnostics> RP Command is used to enable a PWM (“Pulse Width Modulation”) output on the Config pin which is calibrated to show the level the received RF signal is above the sensitivity level of the modem. The PWM pulses vary from zero to 95 percent. Zero percent means the received RF signal is at or below the published sensitivity level of the modem. The following table shows levels above sensitivity and PWM values.

The total period of the PWM output is 8.32 ms. There are 40 steps in the PWM output and therefore the minimum step size is 0.208 ms.

dBm above Sensitivity	PWM percentage (high period / total period)
10	47.5
20	62.5
30	77.5

A non-zero value defines the time that the PWM output will be active with the RSSI value of the last received RF packet. After the set time when no RF packets are received, the PWM output will be set low (0 percent PWM) until another RF packet is received. The PWM output will also be set low at power-up. A parameter value of 0xFF permanently enables the PWM output and it will always reflect the value of the last received RF packet.

PWM output shares the Config input pin. When the modem is powered, the Config pin will be an input. During the power-up sequence, the Config pin will be read to determine whether the modem is going into AT Command Mode. After this, if RP parameter is a non-zero value, the Config pin will be configured as an output and set low until the first RF packet is received. With a non-zero RP parameter, the Config pin will be an input for RP ms after power up.

---

AT Command: ATRP

---

Binary Command: 0x22 (34 decimal)

---

Parameter Range: 0 – 0x7F  
[x 100 milliseconds]

---

Default Parameter Value: 0 (disabled)

---

Number of bytes returned: 1

---

Minimum Firmware Version Required: 4.2AA

---

**RR (Retries) Command**

Networking> RR Command specifies the number of retries that can be sent for a given RF packet. Once RR Command is enabled (set to a non-zero value), RF packet acknowledgements and retries are enabled. After transmitting a packet, the transmitter will wait to receive an acknowledgement from a receiver. If the acknowledgement is not received in the period of time specified by the RN (Delay Slots) Command, the transmitter will transmit the original packet again. The packet will be transmitted repeatedly until an acknowledgement is received or until the packet has been sent RR times.

Note: For retries to work correctly, all modems in the system must have retries enabled.

---

AT Command: ATRR

---

Binary Command: 0x18 (24 decimal)

---

Parameter Range: 0 – 0xFF

---

Default Parameter Value: 0 (disabled)

---

Number of bytes returned: 1

---

Minimum Firmware Version Required: 4.22

---

**RS (RSSI) Command**

<Diagnostics> RS Command returns the signal level of the last packet received. This reading is useful for determining range characteristics of the XStream Modems under various conditions of noise and distance.

Once the command is issued, the modem will return a value between 0x6 and 0x36 where 0x36 represents a very strong signal level and 0x4 indicates a low signal level.

---

AT Command: ATRS

---

Binary Command: 0x1C (28 decimal)

---

Parameter Range: 0x06 – 0x36 [Read-only]

---

Number of bytes returned: 1

---

Minimum Firmware Version Required: 4.22

---

**RT (DI2 Configuration) Command**

<Serial Interfacing> RT command is used to dictate the behavior of the DI2 (RTS/CMD) line. RT Command must be issued to enable RTS flow control or binary programming.

AT Command: ATRT

Binary Command: 0x16 (22 decimal)

Parameter Range: 0 - 2

Parameter Value	Configuration
0	disabled
1	Enable Binary Programming
2	Enable <u>RTS</u> Flow Control

Default Parameter Value: 0

Number of bytes returned: 1

**SH (Serial Number High) Command**

<Diagnostics> Set/Read the serial number high word of the modem.

AT Command: ATSH

Binary Command: 0x25 (37 decimal)

Parameter Range: 0 - 0xFFFF [Read-only]

Number of bytes returned: 2

Related Commands: SL (Serial Number Low)

Minimum Firmware Version Required: 4.27C

**SL (Serial Number Low) Command**

<Diagnostics> Set/Read the serial number low word of the modem.

AT Command: ATSH

Binary Command: 0x26 (38 decimal)

Parameter Range: 0 - 0xFFFF [Read-only]

Number of bytes returned: 2

Related Commands: SH (Serial Number High)

Minimum Firmware Version Required: 4.27C

## SM (Sleep Mode) Command

<Sleep Mode (Low Power)> SM Command is used to adjust Sleep Mode settings. By default, Sleep Mode is disabled and the modem remains continually active. SM Command allows the modem to run in a lower-power state and be configured in one of eight settings.

Cyclic Sleep settings wake the modem after the amount of time designated by SM Command. If the modem detects a wake-up initializer during the time it is awake, it will synchronize with the transmitter and start receiving data after the wake-up initializer runs its duration. Otherwise, it returns to Sleep Mode and continue to cycle in and out of inactivity until the Wake-up Initializer is detected. If a Cyclic Sleep setting is chosen, the ST, LH and HT parameters must also be set as described in the "Sleep Mode" section of this manual.

### Pin Sleep (SM = 1)

Pin Sleep requires the least amount of power. In order to achieve this state, DI3 (SLEEP) pin must be asserted (high). The modem remains in Pin Sleep until the DI3 pin is de-asserted.

After enabling Pin Sleep, DI3 controls whether the XStream Modem is active or in Sleep Mode.

When DI3 is de-asserted (low), the modem is fully operational. When DI3 is asserted (high), the modem transitions to Sleep Mode and remains in its lowest power-consuming state until the DI3 (SLEEP) pin is de-asserted. DI3 is only active if the modem is setup to operate in this mode; otherwise the pin is ignored.

Once in Pin Sleep Mode, DO2 ( $\overline{\text{CTS}}$ ) is de-asserted (high), indicating that data should not be sent to the modem. The PWR pin is also de-asserted (low) when the modem is in Pin Sleep Mode.

### Serial Port Sleep (SM = 2)

Serial Port Sleep is a Sleep Mode in which the XStream Modem runs in a low power state until serial data is detected on the DI pin.

When Serial Port Sleep is enabled, the modem goes into Sleep Mode after a user-defined period of inactivity (no transmitting or receiving of data). This period of time is determined by ST (Time before Sleep) Command. Once a character is received through the DI pin, the modem returns to Idle Mode and is fully operational.

### Cyclic Sleep (SM = 3-8)

Cyclic Sleep is the Sleep Mode in which the XStream Modem enters into a low-power state and awakens periodically to determine if any transmissions are being sent.

When Cyclic Sleep settings are enabled, the XStream Modem goes into Sleep Mode after a user-defined period of inactivity (no transmission or reception on the RF channel). The user-defined period is determined by ST (Time before Sleep) Command.

While the modem is in Cyclic Sleep Mode, DO2 ( $\overline{\text{CTS}}$ ) is de-asserted (high) to indicate that data should not be sent to the modem during this time. When the modem awakens to listen for data, DO2 is asserted and any data received on the DI Pin is transmitted. The PWR pin is also de-asserted (low) when the modem is in Cyclic Sleep Mode.

AT Command: ATSM

Binary Command: 0x01

Parameter Range: 0 - 8

Parameter Value	Configuration
0	Disabled
1	Pin Sleep
2	Serial Port Sleep
3	Cyclic 0.5 second sleep (Modem wakes every 0.5 seconds)
4	Cyclic 1.0 second sleep
5	Cyclic 2.0 second sleep
6	Cyclic 4.0 second sleep
7	Cyclic 8.0 second sleep
8	Cyclic 16.0 second sleep

Default Parameter Value: 0

Number of bytes returned: 1

Related Commands:

Pin Sleep – PC (Power-up Mode), PW (Pin Wake-up)

Serial Port Sleep – ST (Time before Sleep)

Cyclic Sleep – ST (Time before Sleep), LH (Wake-up Initializer Timer), HT (Time Before Wake-up Initializer), PW (Pin Wake-up)

**SM Command (continued)**

The modem remains in Sleep Mode for a user-defined period of time ranging from 0.5 seconds to 16 seconds (SM Parameters 3 through 8). After this interval of time, the modem returns to Idle Mode and listens for a valid data packet for 100 ms. If the modem does not detect valid data (on any frequency), the modem returns to Sleep Mode. If valid data is detected, the modem transitions into Receive Mode and receives incoming RF packets. The modem then returns to Sleep Mode after a Period of inactivity that is determined by ST "Time before Sleep" Command.

The modem can also be configured to wake from cyclic sleep when DI3 (SLEEP) is de-asserted (low). To configure a modem to operate in this manner, PW (Pin Wake-up) Command must be issued. Once DI3 is de-asserted, the modem is forced into Idle Mode and can begin transmitting or receiving data. It remains active until no data is detected for the period of time specified by the ST Command, at which point it resumes its low-power cyclic state.

**Note:** The cyclic interval time defined by SM (Sleep Mode) Command must be shorter than the interval time defined by LH (Wake-up Initializer Timer).

For example: If SM=4 (Cyclic 1.0 second sleep), the LH Parameter should equal 0x0B ("1.1" seconds). With these parameters set, there is no risk of the receiving modem being asleep for the duration of wake-up initializer transmission. "Cyclic Scanning" explains in further detail the relationship between "Cyclic Sleep" and "Wake-up Initializer Timer"

**Cyclic Scanning.** Each RF transmission consists of an RF Initializer and payload. The wake-up initializer contains initialization information and all receiving modems must wake during the wake-up initializer portion of data transmission in order to be synchronized with the transmitting modem and receive the data.

**Figure 4.3. Correct Configuration (LH > SM)**

Length of the wake-up initializer exceeds the time interval of Cyclic Sleep. The receiver is guaranteed to detect the wake-up initializer and receive the accompanying payload data.

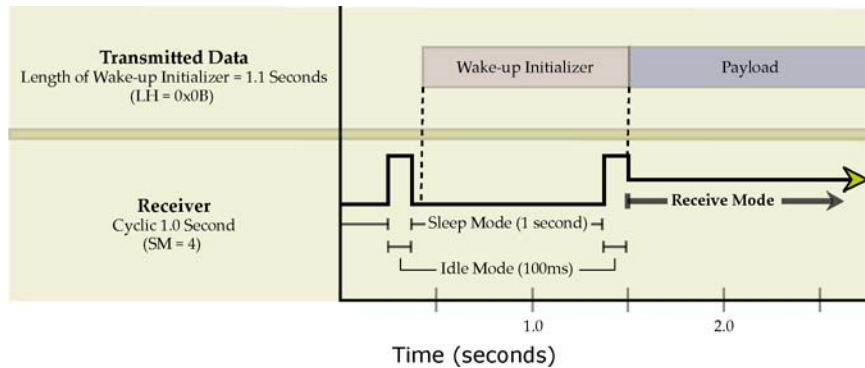

**Figure 4.4. Incorrect Configuration (LH < SM)**

Length of wake-up initializer is shorter than the time interval of Cyclic Sleep. This configuration is vulnerable to the receiver waking and missing the wake-up initializer (and therefore also the accompanying payload data).

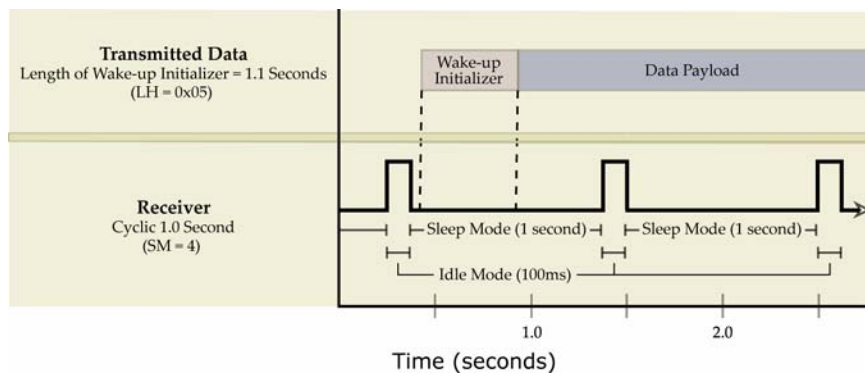

**ST (Time before Sleep) Command**

<Sleep Mode (Low Power)> ST Command sets the period of time (in tenths of seconds) in which the modem remains inactive before entering into Sleep Mode. For example, if the ST Parameter is set to 0x64 (100 decimal), the modem will enter into Sleep mode after 10 seconds of inactivity (no transmitting or receiving). This command can only be used if Cyclic Sleep or Serial Port Sleep Mode settings have been selected using SM (Sleep Mode) Command.

AT Command: ATST  
 Binary Command: 0x02  
 Parameter Range: 0x10 – 0xFFFF  
 [x 100 milliseconds]  
 Default Parameter Value: 0x64 (100 decimal)  
 Number of bytes returned: 2  
 Related Commands: SM (Sleep Mode), LH (Wake-up Initializer Timer), HT (Time before Wake-up Initializer)

**SY (Time before Initialization) Command**

<Networking> SY Command keeps a communication channel open as long as modem transmits or receives before the active connection expires. It can be used to reduce latency in a query/response sequence and should be set 100 ms longer than the delay between transmissions. This command allows multiple XStream Modems to share a hopping channel for a given amount of time after receiving data. By default, all packets include an RF initializer that contains channel information used to synchronize any listening receivers to the transmitter’s hopping pattern. Once a new modem comes within range or is powered on within range, it is able to instantly synchronize to the transmitter and start receiving data. If no new modems are introduced into the system, the synchronization information becomes redundant once modems have become synchronized.

SY Command allows the modems to remove this information from the RF Initializer after the initial synchronization. For example, changing the SY Parameter to 0x14 (20 decimal) allows all modems to remain in sync for 2 seconds after the last data packet was received. Synchronization information is not re-sent unless transmission stops for more than 2 seconds. This command allows significant savings in packet transmission time.

**Warning:** Not recommended for use in an interference-prone environment. Interference can break up the session and the communications channel will not be available again until SY time expires.

With SY set to zero, the channel session is opened and closed with each transmission - resulting in a more robust link with more latency.

**TR (Transmit Error Count) Command**

<Diagnostics> TR Command records the number of retransmit failures. This number is incremented each time a packet is not acknowledged within the number of retransmits specified by the RR (Retries) Command. It therefore counts the number of packets that were not successfully received and have been dropped. The TR Parameter is not non-volatile and will therefore be reset to zero each time the modem is reset.

AT Command: ATTR  
 Binary Command: 0x1B (27 decimal)  
 Parameter Range: 0 – 0xFFFF  
 Default Parameter Value: 0  
 Number of bytes returned: 2  
 Related Commands: RR (Retries)  
 Minimum Firmware Version Required: 4.22

---

**TT (Streaming Limit) Command**

---

<Networking> TT Command defines a limit on the number of bytes that can be sent out before a random delay is issued. TT Command is used to simulate full-duplex behavior.

If a modem is sending a continuous stream of RF data, a delay is inserted which stops its transmission and allows other modems time to transmit (once it sends number of bytes specified by TT Command). Inserted random delay lasts between 1 & 'RN + 1' delay slots, where each delay slot lasts 38ms.

AT Command: ATTT

---

Binary Command: 0x1A (26 decimal)

---

Parameter Range: 0 - 0xFFFF (0 = disabled)

---

Default Parameter Value: 0xFFFF (65535 decimal)

---

Number of bytes returned: 2

---

Related Commands: RN (Delay Slots)

---

Minimum Firmware Version Required: 4.22

---

**VR (Firmware Version) Command**

---

<Diagnostics> Read the Firmware Version of the XStream Modem.

AT Command: ATVR

---

Binary Command: 0x14 (20 decimal)

---

Parameter Range: 0 - 0xFFFF [Read-only]

---

Number of bytes returned: 2

---

**WR (Write) Command**

---

<(Special)> WR Command writes configurable parameters to the modem's non-volatile memory (Parameter values remain in the modem's memory until overwritten by future use of WR Command).

If changes are made without writing them to non-volatile memory, the modem reverts back to previously saved parameters the next time the modem is powered-on.

AT Command: ATWR

---

Binary Command: 0x08

---

# Appendix A: Agency Certifications

---

## FCC Certification

---

The XStream RF Modem complies with Part 15 of the FCC rules and regulations. Compliance with the labeling requirements, FCC notices and antenna usage guidelines is required.

To fulfill the FCC Certification requirements, the OEM must comply with the following FCC regulations:

1. The system integrator must ensure that the text on the external label provided with this device is placed on the outside of the final product [Figure A.1 for 900 MHz operations or Figure A.2 for 2.4 GHz operations].
2. The XStream RF Modem may be used only with Approved Antennas that have been tested with this modem. [Table A.1 or Table A.2]

### FCC Notices:

---

**IMPORTANT:** The 9XStream (900 MHz) and 24XStream (2.4 GHz) OEM Modems have been certified by the FCC for use with other products without any further certification (as per FCC section 2.1091). Changes or modifications not expressly approved by MaxStream could void the user's authority to operate the equipment.

**IMPORTANT:** OEMs must test their final product to comply with unintentional radiators (FCC section 15.107 and 15.109) before declaring compliance of their final product to Part 15 of the FCC Rules.

**IMPORTANT:** The XStream RF Modems have been certified for remote and base radio applications. If the XStream will be used for portable applications, the device must undergo SAR testing.

---

This equipment has been tested and found to comply with the limits for a Class B digital device, pursuant to Part 15 of the FCC Rules. These limits are designed to provide reasonable protection against harmful interference in a residential installation. This equipment generates, uses and can radiate radio frequency energy and, if not installed and used in accordance with the instructions, may cause harmful interference to radio communications. However, there is no guarantee that interference will not occur in a particular installation. If this equipment does cause harmful interference to radio or television reception, which can be determined by turning the equipment off and on, the user is encouraged to try to correct the interference by one or more of the following measures:

- Re-orient or relocate the receiving antenna.
- Increase the separation between the equipment and receiver.
- Connect the equipment into an outlet on a circuit different from that to which the receiver is connected.
- Consult the dealer or an experienced radio/TV technician for help.

## OEM Labeling Requirements

### Label Warning

 **WARNING** The Original Equipment Manufacturer (OEM) must ensure that FCC labeling requirements are met. This includes a clearly visible label on the outside of the final product enclosure that displays the contents shown in the figure below.

Figure A.1. Required FCC Label for OEM products containing 9XStream (900 MHz) RF Modem

Contains FCC ID: OUR9XSTREAM  
The enclosed device complies with Part 15 of the FCC Rules. Operation is subject to the following two conditions: (1) this device may not cause harmful interference and (2) this device must accept any interference received, including interference that may cause undesired operation.

Figure A.2. Required FCC Label for OEM products containing 24XStream (2.4 GHz) RF Modem

Contains FCC ID: OUR-24XSTREAM  
The enclosed device complies with Part 15 of the FCC Rules. Operation is subject to the following two conditions: (1) this device may not cause harmful interference and (2) this device must accept any interference received, including interference that may cause undesired operation.

## Antenna Usage

### Antenna Warning

 **WARNING:** This device has been tested with Reverse Polarity SMA connectors with the antennas listed in Tables A.1 & A.2 of Appendix A. When integrated in OEM products, fixed antennas require installation preventing end-users from replacing them with non-approved antennas. Antennas not listed in the tables must be tested to comply with FCC Section 15.203 (unique antenna connectors) and Section 15.247 (emissions).

### RF Exposure

 **WARNING:** This equipment is approved only for mobile and base station transmitting devices, separation distances of (i) 20 centimeters or more for antennas with gains < 6 dBi or (ii) 2 meters or more for antennas with gains  $\geq$  6 dBi should be maintained between the antenna of this device and nearby persons during operation. To ensure compliance, operation at distances closer than this is not recommended.

The preceding statement must be included as a CAUTION statement in manuals for OEM products to alert users on FCC RF Exposure compliance.

MaxStream radio modems are pre-FCC approved for use in fixed base station and mobile applications. As long as the antenna is mounted at least 20 cm (8 in) from nearby persons, the application is considered a mobile application. If the antenna will be mounted closer than 20 cm to nearby persons, then the application is considered "portable" and requires an additional test performed on the final product. This test is called the Specific Absorption Rate (SAR) testing and measures the emissions from the radio modem and how they affect the person.

Over 100 additional antennas have been tested and are approved for use with MaxStream 900 MHz Radio Modems (including "Mag Mount", "Dome", "Multi-path" and "Panel" antennas). Because of the large number of approved antennas, MaxStream requests that you send specific information about an antenna you would like to use with the modem and MaxStream will evaluate whether the antenna is covered under our FCC filing. Contact MaxStream.

## FCC-Approved Antennas

**Table A.1. Antennas approved for use with 9XStream (900 MHz) RF Modems.**

Manufacturer	Part Number	Type	Gain	Application	Min. Separation Distance
*	*	Yagi	6.2 dBi	Fixed/Mobile **	20 cm
*	*	Yagi	7.2 dBi	Fixed/Mobile **	20 cm
MaxStream	A09-Y8	Yagi	8.2 dBi	Fixed/Mobile **	20 cm
*	*	Yagi	9.2 dBi	Fixed/Mobile **	20 cm
*	*	Yagi	10.2 dBi	Fixed/Mobile **	20 cm
MaxStream	A09-Y11 (FCC pending)	Yagi	11.2 dBi	Fixed/Mobile **	20 cm
MaxStream	A09-F2	Omni Direct.	2.2 dBi	Fixed **	20 cm
MaxStream	A09-F5	Omni Direct.	5.2 dBi	Fixed **	20 cm
MaxStream	A09-F8	Omni Direct.	8.2 dBi	Fixed **	20 cm
*	*	Omni Direct.	9.2 dBi	Fixed **	20 cm
*	*	Omni Direct.	7.2 dBi	Fixed **	20 cm
MaxStream	A09-M7	Omni Direct.	7.2 dBi	Fixed **	20 cm
MaxStream	A09-H	1/2 wave antenna	2.1 dBi	Fixed/Mobile **	20 cm
MaxStream	A09-HBMM-P5I	1/2 wave antenna	2.1 dBi	Fixed/Mobile **	1 cm
MaxStream	A09-QBMM-P5I	1/4 wave antenna	1.9 dBi	Fixed/Mobile **	1 cm
*	*	1/4 wave integrated wire antenna	1.9 dBi	Fixed/Mobile **	1 cm

**Table A.2. Antennas approved for use with 24XStream (2.4 GHz) RF Modems.**

Manufacturer	Part Number	Type	Gain	Application	Min. Separation Distance
*	*	Yagi	6 dBi	Fixed **	2 m
*	*	Yagi	8.8 dBi	Fixed **	2 m
*	*	Yagi	9 dBi	Fixed **	2 m
*	*	Yagi	10 dBi	Fixed **	2 m
*	*	Yagi	11 dBi	Fixed **	2 m
*	*	Yagi	12 dBi	Fixed **	2 m
*	*	Yagi	12.5 dBi	Fixed **	2 m
*	*	Yagi	13.5 dBi	Fixed **	2 m
*	*	Yagi	15 dBi	Fixed **	2 m
*	*	Omni Direct	2.1 dBi	Fixed/Mobile **	20 cm
*	*	Omni Direct	3 dBi	Fixed/Mobile **	20 cm
*	*	Omni Direct	5 dBi	Fixed/Mobile **	20 cm
*	*	Omni Direct	7.2 dBi	Fixed **	2 m
*	*	Omni Direct	8 dBi	Fixed **	2 m
*	*	Omni Direct	9.5 dBi	Fixed **	2 m
*	*	Omni Direct	10 dBi	Fixed **	2 m
*	*	Omni Direct	12 dBi	Fixed **	2 m
*	*	Omni Direct	15 dBi	Fixed **	2 m
MaxStream	A24-P8	Panel	8.5 dBi	Fixed **	2 m
MaxStream	A24-P13	Panel	13 dBi	Fixed **	2 m
*	*	Panel	14 dBi	Fixed **	2 m
*	*	Panel	15 dBi	Fixed **	2 m
*	*	Panel	16 dBi	Fixed **	2 m
MaxStream	A24-P19	Panel	19 dBi	Fixed **	2 m
MaxStream	A24-HABMM-P6I	Dipole	2.1 dBi	Fixed/Mobile **	20 cm
MaxStream	A24-HBMM-P6I	Dipole	2.1 dBi	Fixed/Mobile **	20 cm
MaxStream	A24-HABSM	Dipole	2.1 dBi	Fixed/Mobile **	20 cm
MaxStream	A24-QABMM-P6I	Monopole	1.9 dBi	Fixed/Mobile **	20 cm
*	A24-Q1	Monopole	1.9 dBi	Fixed/Mobile **	20 cm
*	*	Monopole	1.9 dBi	Fixed/Mobile **	20cm

\* FCC-approved antennas not inventoried by MaxStream – Contact MaxStream (866) 765-9885 for information.

\*\* Can be approved for portable applications if integrator gains approval through SAR testing

## European Compliance (2.4 GHz only)

The 24XStream has been certified for use in several European countries. For a complete list, refer to <http://www.maxstream.net>.

If the 24XStream modems are incorporated into a product, the manufacturer must ensure compliance of the final product to the European harmonized EMC and low-voltage/safety standards. A Declaration of Conformity must be issued for each of these standards and kept on file as described in Annex II of the R&TTE Directive. Furthermore, the manufacturer must maintain a copy of the XStream user manual documentation and ensure the final product does not exceed the specified power ratings, antenna specifications, and/or installation requirements as specified in the user manual. If any of these specifications are exceeded in the final product, a submission must be made to a notified body for compliance testing to all required standards.

### OEM Labeling Requirements

The 'CE' marking must be affixed to a visible location on the OEM product.

Figure A.3. CE Labeling Requirements

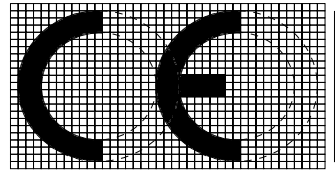

The CE mark shall consist of the initials "CE" taking the following form:

- If the CE marking is reduced or enlarged, the proportions given in the above graduated drawing must be respected.
- The CE marking must have a height of at least 5mm except where this is not possible on account of the nature of the apparatus.
- The CE marking must be affixed visibly, legibly, and indelibly.

Furthermore, since the usage of the 2400 – 2483.5 MHz band is not harmonized throughout Europe, the Restriction sign must be placed to the right of the 'CE' marking as shown below. See the R&TTE Directive, Article 12 and Annex VII for more information

Figure A.4. CE Label Required on OEM Equipment



## Restrictions

France – France imposes restrictions on the 2.4 GHz band. Go to [www.art-telecom.fr](http://www.art-telecom.fr) or contact MaxStream for more information.

Norway – Norway prohibits operation near Ny-Alesund in Svalbard. More information can be found at the Norway Posts and Telecommunications site ([www.npt.no](http://www.npt.no)).

### 24XStream Declarations of Conformity

MaxStream has issued Declarations of Conformity for the 24XStream modems concerning emissions, EMC and safety. Files are located in the 'documentation' folder of the MaxStream CD.

### Important Note

MaxStream does not list the entire set of standards that must be met for each country. MaxStream customers assume full responsibility for learning and meeting the required guidelines for each country in their distribution market. For more information relating to European compliance of an OEM product incorporating the 24XStream modem, contact MaxStream, or refer to the following web sites:

CEPT ERC 70-03E – Technical Requirements, European restrictions and general requirements: Available at [www.ero.dk/](http://www.ero.dk/)

R&TTE Directive – Equipment requirements, placement on market: Available at [www.ero.dk/](http://www.ero.dk/)

### Notifications and Required Information

Since the 2.4 GHz band is not harmonized throughout Europe, a notification must be sent to each country prior to shipping product according to Article 6.4 of the R&TTE Directive. A list of national contacts for most European countries may be found at [www.ero.dk/](http://www.ero.dk/).

The following technical data (relating to the 24XStream) is often required in filling out a notification form.

- Frequency Band: 2400.0 – 2483.5 MHz
- Modulation: Frequency Shift Keying
- Channel Spacing: 400 kHz
- ITU Classification: 400KF1D
- Output Power: 100 mW EIRP
- Notified Body Number: 0891

Contact MaxStream (801) 765-9885 if additional information is required.

### Europe (2.4 GHz) Approved Antenna List

Table A.3. Antennas approved for use with 24XStream (2.4 GHz) RF Modems in Europe

Manufacturer	Part Number	Type	Gain	Application	Minimum Separation Distance
MaxStream	A24-HABMM-P6I	Dipole	2.1 dBi	Fixed/Mobile *	20cm
MaxStream	A24-HBMM-P6I	Dipole	2.1 dBi	Fixed/Mobile *	20cm
MaxStream	A24-HABSM	Dipole	2.1 dBi	Fixed/Mobile *	20cm
MaxStream	A24-QABMM-P6I	Monopole	1.9 dBi	Fixed/Mobile *	20cm
MaxStream	A24-QBMM-P6I	Monopole	1.9 dBi	Fixed/Mobile *	20cm
MaxStream	A24-Q1	Monopole	1.9 dBi	Fixed/Mobile *	20cm

\* Can be approved for portable applications if integrator gains approval through SAR testing

### IC (Industry Canada) Certification

Labeling requirements for Industry Canada are similar to those of the FCC. A clearly visible label on the outside of the final product enclosure must display the following text:

**Contains Model 9XStream Radio (900 MHz), IC: 4214A-9XSTREAM**  
**Contains Model 24XStream Radio (2.4 GHz), IC: 4214A 12008**

Integrator is responsible for its product to comply with IC ICES-003 & FCC Part 15, Sub. B - Unintentional Radiators. ICES-003 is the same as FCC Part 15 Sub. B and Industry Canada accepts FCC test report or CISPR 22 test report for compliance with ICES-003.

# Appendix B: Development Guide

## RS-232 Accessories Kit Contents

The accessories listed below are included with XStream RF Modems that carry the “-RA” suffix on the product number. For example: Part number “X09-019PKC-RA” includes the listed accessories and part number “X09-019PKC-R” does not. The accessories kit includes hardware and software needed for developing long range wireless links. For testing the modem’s range, MaxStream recommends the purchase of one RF Modem with the accessories and one without.

**Table B.1. Accessories Kit Contents**

Item	Qty.	Description	Part Number
Quick Start Guide	1	Familiarizes users with some of the modem’s most important functions.	MD0019
CD	1	Contains documentation, software and tools needed for RF operation.	MD0018
XStream-PKG-R™ RS-232/485 RF Modem	1	Long Range RF Modem with RPSMA Connector	X09... or X19...
Antenna	1	RPSMA, 6" Half-Wave, dipole, articulating	A09-HASM-675
Serial Loopback Adapter	1	Connects to the female RS-232 (DB-9) serial connector of the Interface Board and can be used to configure the modem to function as a repeater (for range testing)	JD2D3-CDL-A
NULL Modem Adapter (male-to-male)	1	Connects to the female RS-232 (DB-9) serial connector of the Interface Board and can be used to connect the modem to another DCE (female DB9) device	JD2D2-CDN-A
NULL Modem Adapter (female-to-female)	1	Used to bypass radios to verify serial cabling is functioning properly	JD3D3-CDN-A
Male DB-9 to RJ-45 Adapter	1	Facilitates adapting the DB-9 Connector of the Interface Board to a CAT5 cable (male DB9 to female RJ45)	JE1D2-CDA-A
Female DB-9 to RJ-45 Adapter	1	Facilitates adapting the DB-9 Connector of the Interface Board to a CAT5 cable (female DB9 to female RJ45)	JE1D3-CDA-A
Power Adapter	1	Allows Interface Board to be powered by a 110 Volt AC power supply	JP4P2-9V10-6F
RS-232 Cable (6')	1	Connects interface board to devices having an RS-232 serial port	JD2D3-CDS-6F

## Adapters

The XStream Development Kit comes with several adapters that support the following functions:

- Performing Range Tests (Serial Loopback)
- Connecting to other RS-232 DCE and DTE devices (Male-to-Male NULL modem)
- Testing Cables (Female-to-Female NULL modem)
- Connecting to terminal blocks or RJ-45 (for RS-485/422 devices)

### Serial Loopback Adapter

Part Number: JD2D3-CDL-A (Red, DB-9 M-F) The serial loopback adapter is used for range testing. During a range test, the serial loopback adapter configures the radio modem to function as a repeater by looping serial data back into the radio for retransmission.

Figure B.1. Serial loopback adapter and pinouts

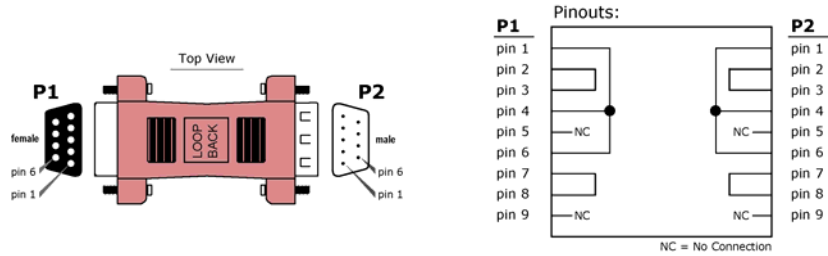

### NULL Modem Adapter (male-to-male)

Part Number: JD2D2-CDN-A (Black, DB-9 M-M) The male-to-male NULL modem adapter is used to connect two DCE devices. A DCE device connects with a straight-through cable to the male serial port of a computer (DTE).

Figure B.2. Male NULL modem adapter and pinouts

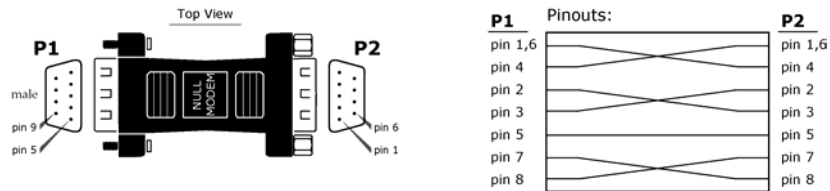

Figure B.3. Example of a MaxStream Radio Modem (DCE Device) connecting to another DCE device



### NULL Modem Adapter (female-to-female)

Part Number: JD3D3-CDN-A (Gray, DB-9 F-F) The female-to-female NULL modem adapter is used to verify serial cabling is functioning properly. To test cables, insert the female-to-female NULL modem adapter in place of a pair of modem assemblies (XIB-R-R interface board + XStream Modem) and test the connection without radio modems in the connection.

Figure B.4. Female NULL modem adapter and pinouts

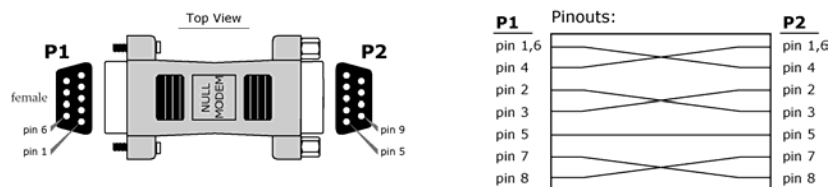

For use in RS-485/422 systems: DB-9 to RJ-45 adapters are illustrated on p11.

## Antennas

[Refer to Appendix A for a list of FCC-Approved Antennas]

Factors that determine wireless link range:

- Ambient RF noise (interference)
- Line-of-sight obstructions
- Transmit power
- Receive sensitivity
- Antenna configuration
- XStream Antenna Connector Options

To comply with the FCC rules and obtain a “modular” certification, it is required that XStream Modems utilize a “non-standard” connector. This is to ensure the modems are used only with approved antennas.

### RPSMA

The Reverse Polarity SMA (RPSMA) connector uses the same body as a regular SMA connector. In order to be a “non standard” connector, the gender of the center conductor is changed. The female RPSMA actually has a male center conductor.



## Antenna Cables

RF cables are typically used to connect a radio installed in a cabinet to an antenna mounted externally. As a general rule, it is best to keep the RF cable as short as possible. All cables promote signal loss which is usually measured in dB loss per 100 ft. MaxStream provides LMR-195 rated cables. Common cables and dB losses are included in this table:

Table B.2. Potential Signal Strength Loss due to Antenna Cable Length

Cable Type	Loss at 900 MHz per 100' (loss per 100m)	Loss at 2.4 GHz per 100' (loss per 100m)	Diameter
RG-58	14.5 dB (47.4 dB)	25.3 dB (83.2 dB)	0.20" (4.95 mm)
RG-174	25.9 dB (85.0 dB)	44.4 dB (145.8 dB)	0.10" (2.54 mm)
RG-316	24.7 dB (81.0 dB)	42.4 dB (139.0 dB)	0.10" (2.59 mm)
LMR-195	11.1 dB (36.5 dB)	19.0 dB (62.4 dB)	0.20" (4.95 mm)
LMR-240	7.6 dB (24.8 dB)	12.9 dB (42.4 dB)	0.24" (6.10 mm)
LMR-600	2.5 dB (8.2 dB)	4.4 dB (14.5 dB)	0.59" (15.0 mm)

# Appendix C: Additional Information

## 1-Year Warranty

XStream RF Modems from MaxStream, Inc. (the "Product") are warranted against defects in materials and workmanship under normal use, for a period of 1-year from the date of purchase. In the event of a product failure due to materials or workmanship, MaxStream will repair or replace the defective product. For warranty service, return the defective product to MaxStream, shipping prepaid, for prompt repair or replacement.

The foregoing sets forth the full extent of MaxStream's warranties regarding the Product. Repair or replacement at MaxStream's option is the exclusive remedy. THIS WARRANTY IS GIVEN IN LIEU OF ALL OTHER WARRANTIES, EXPRESS OR IMPLIED, AND MAXSTREAM SPECIFICALLY DISCLAIMS ALL WARRANTIES OF MERCHANTABILITY OR FITNESS FOR A PARTICULAR PURPOSE. IN NO EVENT SHALL MAXSTREAM, ITS SUPPLIERS OR LICENSORS BE LIABLE FOR DAMAGES IN EXCESS OF THE PURCHASE PRICE OF THE PRODUCT, FOR ANY LOSS OF USE, LOSS OF TIME, INCONVENIENCE, COMMERCIAL LOSS, LOST PROFITS OR SAVINGS, OR OTHER INCIDENTAL, SPECIAL OR CONSEQUENTIAL DAMAGES ARISING OUT OF THE USE OR INABILITY TO USE THE PRODUCT, TO THE FULL EXTENT SUCH MAY BE DISCLAIMED BY LAW. SOME STATES DO NOT ALLOW THE EXCLUSION OR LIMITATION OF INCIDENTAL OR CONSEQUENTIAL DAMAGES. THEREFOR, THE FOREGOING EXCLUSIONS MAY NOT APPLY IN ALL CASES. This warranty provides specific legal rights. Other rights which vary from state to state may also apply.

## Ordering Information

Figure C.1 MaxStream RF Modem Part Numbers Key

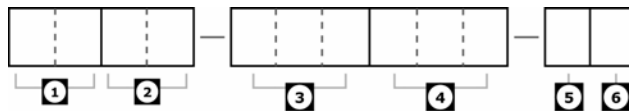

Divisions of the MaxStream PKG RF Modem part numbers:

**1 MaxStream Product Family**

XC = XCite  
X = XStream  
XT = XTend

**2 Operating Frequency**

09 = 902-928 MHz  
24 = 2.4000 - 2.4835 GHz  
(XStream only)  
H9 = 923 MHz (XStream only)

**3 RF Data Rate (baud)**

001 = 1200 bps (XStream only)  
009 = 9600 bps  
019 = 19200 bps (XStream only)  
038 = 38400 bps (XCite Only)  
(blank) All XTend RF Modems support  
1200 to 115200 bps (software selectable)

**4 Operating Temperature**

PKC = Commercial: 0 to 70° C  
PKI = Industrial: -40 to 85° C. Embedded RF Module is Conformal Coated  
PKT = Tested Industrial: -40 to 85° C. Embedded RF Module is Conformal Coated & 100% tested

**5 Serial Interface (Connector)**

R = RS-232, RS-485/422  
U = USB  
E = Ethernet  
T = Telephone

**6 Accessories Package**

A = Accessories Package (specific to the Serial Interface) Included  
(blank) means the accessories package is not included

## Contact MaxStream

---

Free and unlimited technical support is included with every MaxStream Radio Modem sold.  
Please use the following resources for additional support:

Documentation:	<a href="http://www.maxstream.net/helpdesk/download.php">http://www.maxstream.net/helpdesk/download.php</a>	
Technical Support:	Phone.	(866) 765-9885 toll-free U.S. & Canada (801) 765-9885 Worldwide
	Live Chat.	<a href="http://www.maxstream.net">www.maxstream.net</a>
	E-Mail.	<a href="mailto:rf-xperts@maxstream.net">rf-xperts@maxstream.net</a>

MaxStream office hours are 8:00 am – 5:00 pm [U.S. Mountain Standard Time]